



DISPLAY COLLECTION



SHOWCARD FRAME SYSTEMS



SUSPENSION SYSTEMS



ELECTRONIC SHELF MARKING



CHECKOUT AND SALES MARKING



ACRYLIC DISPLAYS & PVC-PRODUCTS



ALUMINIUM DISPLAYS

DISPLAY COLLECTION

WELCOME



Dear customers, dear prospects,

you are holding in hands our comprehensive catalogue **"Display Collection"** which offers you an overview of our complete product range in the fields of LED lighting technology, product labelling and general sales promotion. On more than 200 pages in a new design you will find interesting novelties and proven products of best Oechsle quality and practicality.

The constant changes of the market demand practice-oriented answers and solutions: In close cooperation with our customers and partners we are constantly developing **new demand-responsive products** for the effective **application at the Point of Sale**. On the following pages you will find many innovative suggestions and useful application examples for your presentation. You will see: Oechsle provides nearly everything you need for a perfect presentation at the POS.

Because shelf organization is such a complex field, we decided to provide a special brochure **"PRIMA shelf-management systems"**. So while the comprehensive catalogue deliberately deals with the field in short, the extra brochure gives you a clearly structured overview of all products in shelf-management systems and is enhanced with numerous illustrated examples of application.

Last but not least we would like to introduce our strong partner **werba print und display** on the following pages. We will explain why OEK and werba are such an unbeatable team. The brochure "Display & POS Solutions" contains detailed information and interesting facts on werba's array of services; you can order it for mail delivery or retrieve it directly from our website www.oechsle.de. By the way, you may browse in or **directly download** this catalogue as well as all other OEK brochures from our homepage.

We would be very glad to receive your individual and specific product requirements. Our motivated team will competently commit itself to your concerns and, if required, will develop individual **made-to-measure solutions** at any time – just contact us. My staff will gladly arrange a personal meeting and provide you with more detailed information.

We are looking forward to a successful and pleasant cooperation.

Yours,
Margit Oechsle
Managing Director



WHO WE ARE	5	SHELF EQUIPMENT	77
SHELF MANAGEMENT SYSTEMS	12	Klick shelf barkers / acrylic frames	78
LED-DISPLAYS AND LIGHTING SYSTEMS	14	Klick ticket holders/Klick accessories	79
SHOWCARD FRAME SYSTEMS	17	Klick accessories (series 300)	80
Dekoline	18	Shopper stoppers	88
Laminate	19	Shopper stopper accessories	89
Twin-Set	20	Shopper stopper	90
Standard	21	Banner hangers	92
Basic	23	Shopper stopper for scanner rails	94
Protectors	24	Shopper stopper / shopper wobblers	96
Special sizes	25	Delicatessen & Counter marking Signholder	98
Greenline	29	Signholder	112
Accessories	31	Accessories for peg-board hooks	114
		Scanner rails	115
Components / bases	48	ELECTRONIC SHELF MARKING	119
Components / magnetic fixings	52	Fasteners for Pricer labels	121
Components / various components / tubes	53	Fasteners for Solu M (Samsung)	123
Components / tubes	54	Fasteners ESL SES-Imagotag / Delfi (Display Data)	124
Components / T-pieces	56	Fasteners for glass-, wire boards & scanner rails	125
Components / acrylic covers / -holders	58	Fasteners for peg-board hooks	126
Components / various accessories	59	ESL Klick accessories	127
Showcard stands	61	ESL supports for shelving and counters	128
Floor standing stands	68	ESL cardboard clamps	129
Gallow stands	72	CHECKOUT AND SALES MARKING	131
Showcard holders	73	Checkout dividers	132
		Cash tray	134
		Infoline	135
		Posterline	139
		Advertising on shopping trolleys / shopping baskets	140
		Storage and sales container	142

TABLE OF CONTENTS

PAGE 143 TO 212

SUSPENSION SYSTEMS	143	ALUMINIUM DISPLAYS	179
Poster rails	144	LED snap-type frames	180
Accessories for poster rails	147	Alu snap-type frames	181
Poster rail round tube	150	Alu infostand and tensile frame	185
System tube QP with accessories	151	Alu profile frames	186
Priceboard	153	Alu profile frames – showcard stand	187
Clamp- and snap rails	154	Alu profile frames accessories	188
Mounting accessories	155	Pavement supports	192
Marking for beverages	158	Leaflet dispenser	196
ACRYLIC DISPLAYS & PVC-PRODUCTS	163	OUR STRONG PARTNER WERBA	198
Acrylic displays	164	INDEX	206
Acrylic showcard stands	165	GENERAL TERMS AND CONDITIONS	210
Acrylic supports	166	CONTACT FORM	211
Acrylic boxes	169	COLOR CHART	212
PVC-price tag pockets	170		
WOODLINE	172		
Wooden frames	173		
Components and accessories	174		
Wooden showcard stands	175		
Table stands	176		
Checkout and pavement supports	177		
Wooden shelving	178		

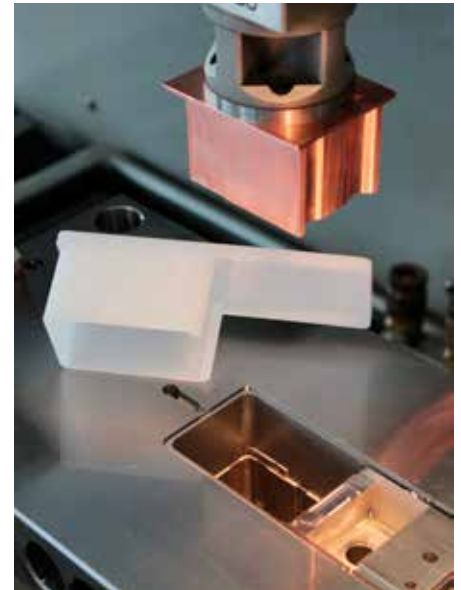

PRIME QUALITY THROUGH PRECISION

INDIVIDUAL AND SERIES SOLUTIONS FROM ONE SOURCE

Our extensive product range includes nearly everything you need for a perfect presentation at your point of sale. Nevertheless, we are also aware that special requirements demand extraordinary, product-specific realizations. Besides the construction and manufacturing of our tried and tested series-production range, one of our company's strengths lies in the development of individual special solutions: In close cooperation with the client, design, practicality and technology are tailored to their specific needs.



WE WILL TRANSFORM YOUR WISH INTO FORM AND FUNCTION

You have a specific request? Oechsle will create a solution of optimum form and functionality. Our well-coordinated, experienced team of design engineers, model makers and manufacturing technicians precisely tailors design and technology to your requirements. In addition, we manufacture 3-D prototypes as functional models as well as for your evaluation and approval.



OUR PRECISION TOOLS ENSURE PRIME QUALITY

Due to our own engineering department and our on-site tool construction we are able to react to our customer's wishes in a fast and flexible manner. Our team manufactures injection mouldings within 4-10 weeks, depending on the product's complexity.

The professional expertise we have acquired over decades combined with our highly efficient technical equipment ensure an economical production of your final product. Meanwhile our team has developed and produced around 1.000 injection mouldings.

The professional maintenance of these tools enables decades of availability guarantee for the products manufactured with them.

Benefit from our experience and expertise!



WHO WE ARE

PLASTICS INJECTION MOULDING



INJECTION MOULDING IN PERFECTION

Our medium-sized company is a leading manufacturer of quality products made from plastics injection moulding. Since more than 60 years we develop and produce an extensive array of products in the field of price labelling, sales promotion and shelf-management: These products made in Leipheim are in use all around the globe.

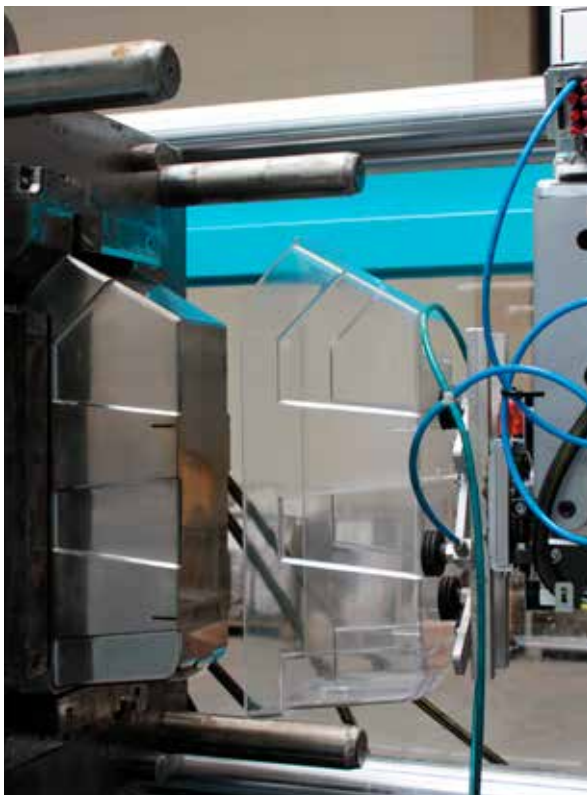

An efficient workflow and technically ultra-modern machinery allow us to achieve a maximum amount of flexibility.

FACTS AND FIGURES

- Our modern machinery is comprised of 36 injection moulding machines of well-known manufacturers. We produce parts with a weight of 1 – 1.200 grams.
- The suitable material for each product: We keep a choice of more than 25 different kinds of plastics granules.
- We annually process over 500 tons of raw materials to create your desired products.
- Permanent maintenance of our machines by our own qualified workers guarantees best and steady product quality.



OUR ARRAY OF SERVICES IN THE FIELD OF PLASTICS INJECTION MOULDING

PORTFOLIO OF SHOWCARD FRAMES

- Showcard frames, showcard stands and price displays, each with an extensive range of suitable accessories like holders, hooks, rings, clamps,...
- T-pieces and base plates for our customizable showcard stands
- Delicatessen price cassettes, acrylic displays, cardholders, signclips
- Fasteners for electronic price labelling (ESL fasteners)



SHELF MANAGEMENT AND LABELLING

- Shelf management systems consisting of individually combinable merchandise dividers and pusher systems with accessories for an efficient presentation of goods at the POS: Shelf dividers, pusher systems, roller conveyors, slide rails, ...
- Shelf labelling, shelf stoppers, banner mounts
- ESL fasteners for electronic price labels



CUSTOMIZED PRODUCTS

- Individual customer-specific products for industry and trade

WHO WE ARE

ALUMINIUM PROCESSING



ALUMINIUM BROUGHT INTO SHAPE



We annually process over half a million linear metres aluminium profiles to create high quality end products. Solid quality, precise workmanship, durability and resilience characterize our aluminium products. This is the reason why the name Oechsle also stands for prime quality aluminium products.

SEE AND FEEL THE DIFFERENCE

Also in the field of aluminium processing the realization of customer-specific requests is part of our daily routine. We can supply you with any type of model, ranging from individual items to large series, from productions in standard DIN-formats to special productions in the size you prefer.



OUR ARRAY OF SERVICES:

- LED lighting strips with accessories
- LED folding monotube frames with accessories
- LED displays and hot spot merchandising fixtures
- Suspension rails in various designs
- Clamp- and snap rails
- Wall- and window snap-type frames
- Profile frames and profile frame displays
- Pavement supports for indoor and outdoor use
- Banner stands
- Brochure stands
- Special displays

OEK-LEDLINE: WE ILLUMINATE YOUR POINT OF SALE

Oechsle's LEDline products let your merchandise and promotional messages shine. We provide your shelves and your point of sale with the suitable lighting.

Constant new developments in wholesale and retail, the service industry but also for individual clients rapidly led to the creation of an extensive product range of LED lighting technology.

Whether soft white, neutral white or daylight white – we offer the complete range of LED lighting colors. This way, we can implement the most visual appealing and hence the most promotionally effective presentation for every merchandise sector.

FOR YOU WE DEVELOP AND PRODUCE:

- LED-shelf lighting complete solutions including power supply and fastening technology or individual solutions
- Illuminated advertising and price labelling
- LED-displays and merchandising fixtures (hot spots)
- LED folding monotube frames



Lighting is so much more than product or sales room illumination: It is an emotional design tool that enhances sales promotion. If used in the right way, it can create product worlds.

Become a director and set the stage – with LED products by Oechsle.



Shelf without illumination



Shelf with illumination

WHO WE ARE PAD PRINTING



INDIVIDUALIZATION MADE EASY

Moulds imprinted straight away, directly from the manufacturer – Oechsle offers full service with four-color pad printing.



→ Imprinting our new keyring pendants with shopping cart coin



The Teca-Print machine prints logos with up to four colors. The closed ink well system guarantees a consistent standard of printing quality, even with large quantities. The size range of the print image starts with dimensions of a few millimeters (8 x 8 mm) and reaches up to an average of 70 mm.

Pad printing is optimally suitable for the printing of fine lines (0,3 mm) and logotypes, both on arched and flat surfaces. Hence components such as T-pieces, acrylic holders and frames, price tag holders and many more can be imprinted directly after production: Without additional logistic expenditure, inexpensive, fast and in highest quality.



Pad printing already pays with quantities of only 1000 pieces:
Give your labelling a distinctive identity!
We shall be pleased to make you an individual offer that meets your wishes.
We are looking forward to your request.



SC-CHIP
Shopping cart chip in €-coin size with holder (two-piece) made of plastic, red. Other standard colors available upon request.

13275-06

On request we will gladly make you an offer for individual pad printing as well as for the production of an entire key fob with pendant and chain.



SHELF MANAGEMENT SYSTEMS



SHELF MANAGEMENT SYSTEMS

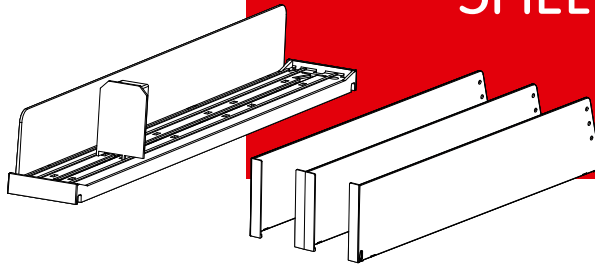

SHELF DIVIDERS



PUSHER SYSTEMS



SPECIAL APPLICATIONS



SHELF MANAGEMENT SYSTEMS

ASK FOR OUR SPECIAL CATALOGUE

MORE EFFICIENCY – LESS MAINTENANCE

Our shelf management and pusher systems PRIMA and PVR offer a variety of solutions for the promotional presentation and a fast, efficient and hence economical maintenance of merchandise shelves.

You will optimize your visual merchandise presentation with our meanwhile million fold applied shelf dividers, pushers and accessory components. At the same time you will minimize costs for shelf maintenance and increase your efficiency.

Because shelf organization is such a complex field, we decided to provide you with a special catalogue that gives you a clearly structured overview of all products in shelf-management systems and is enhanced with numerous illustrated examples of application.

Ask us for your printed catalogue or use the digital edition on our website: www.oechsle.de
Here, you may browse in the catalogue or can directly download it as PDF.



Your direct link to the digital catalogue



NEW IN THE ASSORTMENT



PRIMA roller conveyor XL



PRIMA slide rail



Pushers for freezer areas



SRP - Shelf Ready Packaging



PRIMA PTF - "Pull To Front"



PRIMA 2.0 - The new generation



LED DISPLAYS AND LIGHTING SYSTEMS

LIGHT AT THE POINT OF SALE

Lighting is so much more than product or sales room illumination: It is an emotional design tool that enhances sales promotion.

If used in the right way, it can create product worlds. As humans perceive 80% of their surroundings through sight, light is a crucial factor that plays a vital role in purchasing decisions.

Become a director and set the stage – with LED products by Oechsle.

WE ILLUMINATE YOUR MERCHANDISE

Our LEDline products let your merchandise and promotional messages shine.

Our special catalogue contains the complete LED product range with detailed product specifications, pictures and examples of application. You can order it for mail delivery or download it from our website at any time.

Your direct link to the online catalogue:



LED LIGHTING STRIPS

LED lighting strips by Oechsle are an ideal means to flexibly meet the demands of contemporary lighting concepts. Especially in lower shelving areas the illumination and hence the visibility of merchandise is insufficient.

Nearly invisible positioned LED lighting strips solve this problem. They can be retrofitted with little effort; technical knowledge is not required for installation.

Whether soft white, neutral white or daylight white – we offer the complete range of LED lighting colors. In other words: The suitable lighting for each product.



ILLUMINATED PROMOTIONAL AND PRICE INFORMATION

In combination with a transparent front rail the Oechsle lighting strips illuminate both price and product information.

But a LED strip made by OEK does more than just bring light into the dark. If positioned accordingly, it lets entire glass bases shine: An effective highlight that definitely attracts the customer's attention.



LEDLINE DISPLAYS AND FOLDING MONOTUBE FRAMES

With LED displays you can set lighting accents at every time of the day. Whether in the sales room or in the display window – your promotional message is an eye catcher in every surrounding. LED displays and folding monotube frames are a convenient solution for everyday use. Produced by Oechsle in solid quality, durable, with low operating costs and easy to handle: With power line, power plug and naturally, the CE mark – ready to use!

LED PRODUCTS IN DESIRED FORMATS

By the way: Not only do we produce LED lighting technology in standard sizes, our production plant in Leipheim also manufactures desired formats according to your specifications. Contact us. We are at your disposal everytime.



LED folding monotube frame. Our example shows a special solution with bracket wall-mounting.



SHOWCARD FRAME SYSTEMS

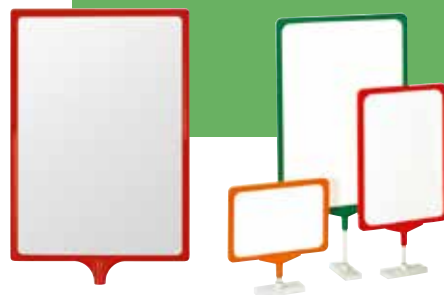

SHOWCARD FRAMES



SHOWCARD STANDS



COMPONENTS



SHOWCARD FRAME SYSTEMS

DEKOLINE

DEKOLINE – YOUR TRENDY PROMOTION AID FOR BOOSTING SALES!

Benefit from an exquisite and modern design: with trendy pointed corners and clear lines. The times of average standard are over – today you need a unique and distinctive presentation of your advertising and sales information to promote your products effectively.

For fixing the frames all elements of the → **accessories showcard frames (series 100)** can be used.

Made of unbreakable plastics. Short side poster entry, max. poster thickness 4,5 mm.

COLORS:

In OEK standard colors and silver.

Other colors available upon request.

A5 and A4 are also available in chromium upon request.



DEKOLINE-SHOWCARD STANDS

All three DEKOLINE showcard frame sizes can be expanded to a showcard stand by using a T-piece as connecting element, an optionally extendable or fixed tube or a base. For more details see the following chapter "Showcard Frame Systems Components" and "Showcard Stands".

AVAILABLE SIZES:

The showcard frames from our DEKOLINE series are available in the sizes A5, A4 and A3.

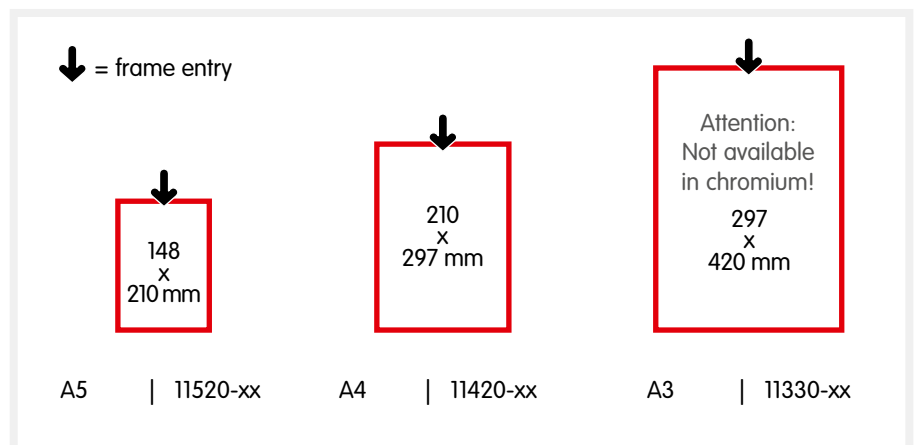

LAMINATE – OFFERING “OVERSIZE”
FOR LAMINATED DIN SIZES.

Especially designed for laminated posters that do not fit into standard frames in DIN sizes, this frame eliminates the need for an uncomfortable “cutting to size” of the laminated inserts.

The frame design is similar to our DEKOLINE series. Short side poster entry, max. poster thickness 4,5 mm (see arrow ↓).

IDEAL FOR OUTDOOR USE

Our laminated showcard frames are especially suited for areas with high humidity or for outdoor use. Also available as poster stand with T-piece, plastic tube and coated base.



Colors:

OEK standard colors, silver.
Other colors available upon request.

Accessories:

For fixing the laminated frames all elements of the
→ **accessories showcard frames (series 100)** can be used.

Available sizes:

Our laminated showcard frames are available in the sizes A5 plus, A4 plus and A3 plus.



↓ = frame entry

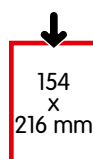

A5 plus | 11508-xx



A4 plus | 11408-xx

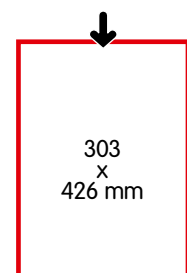

A3 plus | 11308-xx

SHOWCARD FRAME SYSTEMS

TWIN-SET

TWIN-SET – ALLOWING FOR A PROFESSIONAL AND INDIVIDUALIZED APPEARANCE

The basic frame and the lower section can be combined in various colors which help to mark and distinguish different stores and departments. This possibility offers maximum freedom and flexibility in color design.

The basic frame can be used either with or without base cover.



Example showing the special color "petrol lacquered"



WITH LOGO ON REQUEST

The professional look and feel of this series is emphasized by customized logos or branding or additional stickers on the lower section. Customized prints or stickers upon request.

FIXING ACCESSORIES

For fixing the frames all elements for a lateral attachment onto the frame of the → accessories showcard frames (series 100) can be used.



BASIC FRAME A4 LANDSCAPE

To take tubes Ø 10 mm at the frame's bottom. Long side poster entry, max. insert thickness 3 mm. Colors: upon request.

Customized print and neon colors available upon request.

18060-xx

LOWER SECTION

Lower section for basic frame A4, to take tubes Ø 10 mm at the bottom side, height 36 mm. Colors: white, grey, yellow, red, green, blue, black, darkblue. Customized print and neon colors available upon request.

20030-xx



STANDARD – THE CLASSIC FRAME
MADE OF UNBREAKABLE PLASTICS:
WITH A VAST RANGE OF ACCESSORIES

The classic OEK showcard frames have been produced for almost 45 years in traditional quality made of high-grade unbreakable plastics. The extremely stable frames with rounded corners allow for a quick and easy change of posters.



Offering a vast range of accessories the frames can be used for a variety of applications.

You will find the appropriate fixing elements under the heading:
→ **accessories showcard frames (series 100) and (series 200)** following our showcard frame presentation.



Allowing for countless applications if used as showcard stand.

In combination with a T-piece as connecting element, an optionally extendable or fixed tube as well as a base our showcard frames turn into versatile showcard stands.

All T-pieces and bases are available in different shapes and colors for individual combinations. Also the length, thickness and material of the showcard stand tubes can be adjusted according to your specific needs and applications.



We have the appropriate fastener for almost every application no matter whether you need it for hanging, wall mounting or plugging. For more details on our vast range of showcard frame accessories see page 31.

SHOWCARD FRAME SYSTEMS

STANDARD

STANDARD

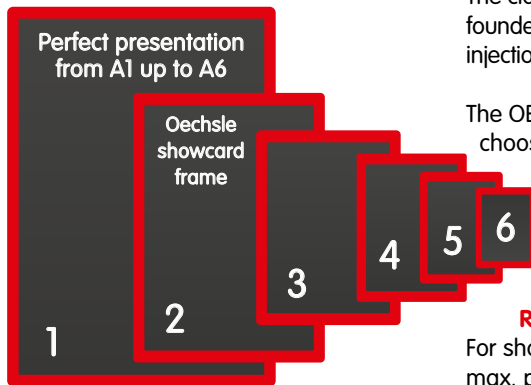

The classic showcard frame made by Oechsle Display Systems. Developed by the company founder Hermann Oechsle in the 1970s the solid and extremely stable profile made of plastic injection molding has meanwhile become international standard at every point of sale.

The OEK standard frame is available in the sizes A6 to A1. With the sizes A6 to A1 you can choose between short or long side frame entry (see arrows ↓ →).

Offering a vast range of accessories which you will find on page 40 under the heading → **accessories showcard frames (series 100) and (series 200)** the frames can be used for a variety of applications.

Remark:

For showcard frames sizes A6 - A3 please use the accessories of the **series 100** with a max. poster insert thickness of up to 3 mm.

For showcard frames sizes A2 – A1 please use the accessories of the **series 200** with a max. poster insert thickness of up to 4 mm.

Colors:

Short side poster entry:

OEK standard colors, additional colors, transparent, metallic silver, silver, chrome.

Long side poster entry (LSE):

OEK standard colors, transparent.

In need of any other colors? If you order at least 500 pcs., we should be happy to produce the frames in any color of your choice. In this case, however, we reserve the right to make an overdelivery or underdelivery of +/- 10%.

105 x 148 mm

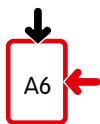

A6 (series 100) | 11600-xx
A6 long side entry | 11601-xx

148 x 210 mm

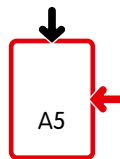

A5 (series 100) | 11500-xx
A5 long side entry | 11501-xx

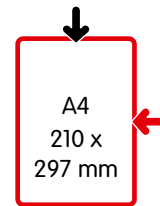

A4 (series 100) | 11400-xx
A4 long side entry | 11401-xx

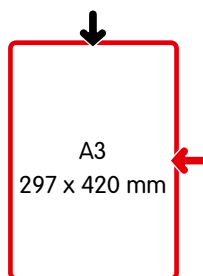

A3 (series 100) | 11300-xx
A3 long side entry | 11301-xx

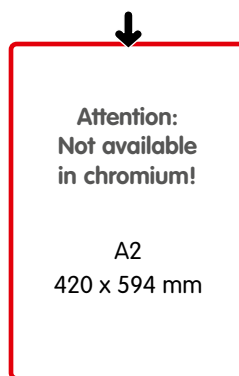

A2 (series 200) | 12200-xx

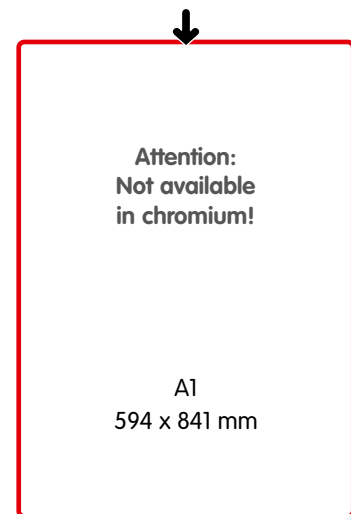

A1 (series 200) | 12100-xx

BASIC – FRAME AND ACCESSORIES MADE IN ONE PIECE

The slim frame profile with pointed corners gives the BASIC a modern and subtle look and feel.

Its delicate contour makes it strikingly inconspicuous, perfectly highlighting your advertising message.

Thanks to its integrated accessory elements it is ready to use very quickly. The BASIC is available either with an already injected T-piece or with injection molded rings for attaching the frames.



BASIC A4 WITH T-PIECE
Showcard frame A4 with integrated T-piece, to directly take tubes Ø 10 mm,

max. insert thickness
2 mm.

Colors: white, grey,
yellow, red, green.
Further colors upon
request.



Basic A4/T

| 11418-xx

BASIC A4 WITH RINGS

Showcard frames A4 with integrated suspension rings in various positions and quantities, max. insert thickness 2 mm, colors: white, grey, yellow, red, green. Further colors upon request.

with 2 rings, shortside | 11431-2S-xx
with 4 rings, shortside | 11432-4S-xx
with 4 rings, longside | 11434-4L-xx

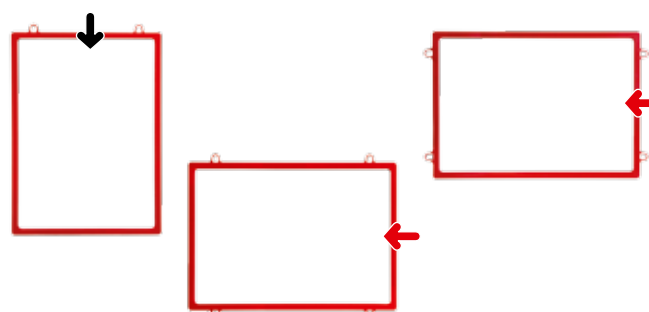

SHOWCARD FRAME SYSTEMS

PROTECTORS

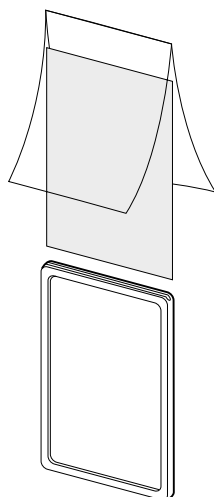

PVC POSTER PROTECTORS

Suitable for showcard frames of same size, folded short side, made of non-reflective, clear PVC.

A6 (0,2 mm)		29100-A6/02
A5 (0,2 mm)		29100-A5/02
A4 (0,2 mm)		29100-A4/02
A3 (0,3 mm)		29100-A3/03
A2 (0,3 mm)		29100-A2/03
A1 (0,4 mm)		29100-A1/04



PVC POSTER PROTECTORS, LS

Suiting all showcard frames of same size, folded long side, non reflective, clear.

A6 (0,2 mm)		29101-A6/02
A5 (0,2 mm)		29101-A5/02
A4 (0,2 mm)		29101-A4/02
A3 (0,3 mm)		29101-A3/03
A2 (0,3 mm)		29101-A2/03



SPECIAL SIZES

Offering more than 25 different types of frames in special sizes we are your perfect partner for customized solutions.

You will find the suitable fixing elements in the next chapter under the heading → **accessories showcard frames (series 100) and (series 200)**.

Colors:
white and red.

In need of any other colors? If you order at least 500 pcs., we should be happy to produce the frames in any color of your choice. In this case, however, we reserve the right to make an overdelivery or underdelivery of +/- 10%.

140 x 89 mm



SERIES 100
5,5" x 3,5" - LSE | 11837-xx

140 x 178 mm

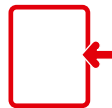

SERIES 100
7" x 5,5" - LSE | 11835-xx

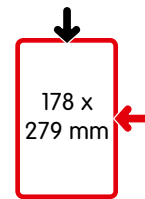

SERIES 100
7" x 11" | 11833-xx
7" x 11" - LSE | 11834-xx



SERIES 100
11" x 14" | 11830-xx

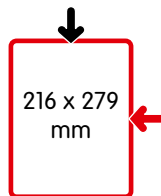

SERIES 100
8,5" x 11" | 11838-xx
8,5" x 11" - LSE | 11839-xx

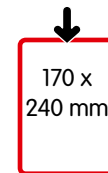

SERIES 100
170 x 240 mm | 11853-xx

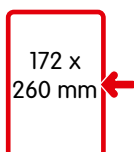

SERIES 100
172 x 260 mm - LSE | 11859-xx



SERIES 100
243 x 340 mm | 11850-xx

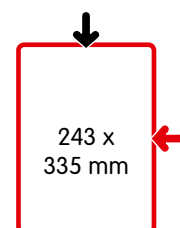

SERIES 100
243 x 335 mm | 11851-xx
243 x 335 mm - LSE | 11852-xx

SHOWCARD FRAME SYSTEMS

SPECIAL SIZES

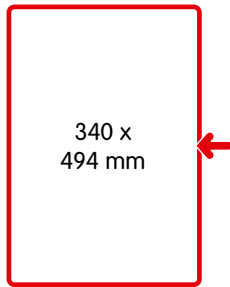

SERIES 100
340 x 494 mm - LSE | 11860-xx

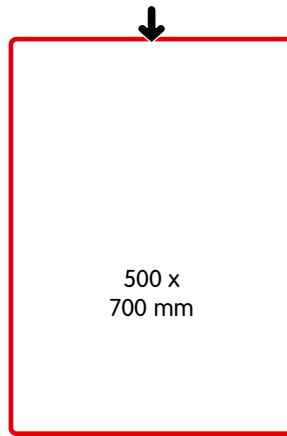

SERIES 200
500 x 700 mm | 12550-xx

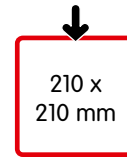

SERIES 100
210 x 210 mm | 11412-06
210 x 210 mm, transparent | 11412-55

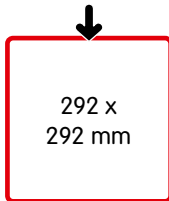

SERIES 200
292 x 292 mm | 12530-xx

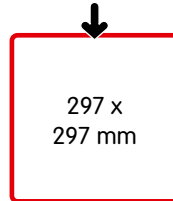

SERIES 100
297 x 297 mm | 11840-xx

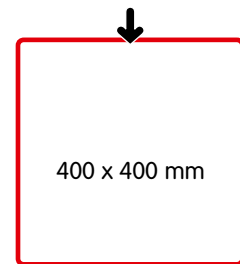

SERIES 100
400 x 400 mm | 11841-xx

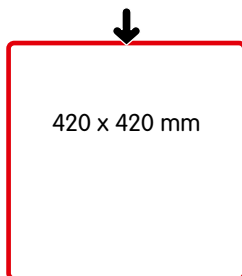

SERIES 100
420 x 420 mm | 11842-xx

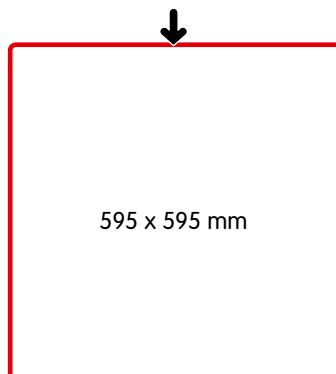

SERIES 200
595 x 595 mm | 12540-xx

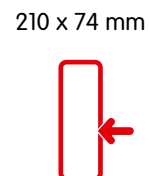

SERIES 100
210 x 74 - LSE, red | 11402-06

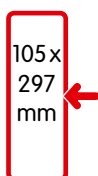

SERIES 100
105 x 297 - LSE | 11857-xx

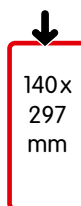

SERIES 100
140 x 297 mm | 11856-xx



SERIES 100
140 x 417 mm | 11855-xx

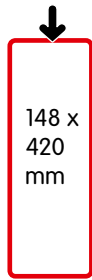

SERIES 100
148 x 420 mm | 11844-xx



SERIES 100
205 x 415 mm | 11854-xx

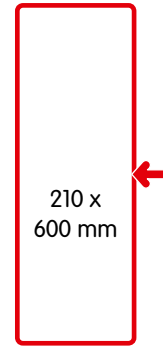

SERIES 200
210 x 600 mm - LSE | 12552-xx



SERIES 200
290 x 595 mm | 12551-xx

A4 WITH CROSS BAR

To insert two posters in different sizes, long side poster entry. Suitable accessories series 100. Colors: upon request.

11404-xx

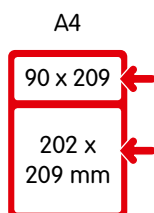

A3 WITH CROSS BAR

To insert two posters in different sizes, long side poster entry. Suitable accessories series 100. Colors: upon request.

11304-xx

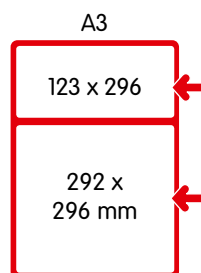

SHOWCARD FRAME WITH CROSS BAR - LSE

Showcard frame with cross bar for posters sizes A4 portrait and A5 landscape, long side poster entry, to be used with accessories (series 100). Colors: white, red, green.

11445-xx

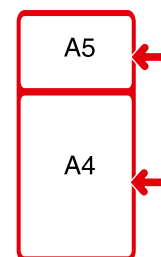

SHOWCARD FRAME SYSTEMS

SPECIAL SIZES

105 x 150 mm



BICYCLE SWIVEL FRAME A6

A6 with cross bar, swivel frame with ball joint and tube clip for Ø 22 mm. Color: white, yellow. Available upon request.

18660-xx

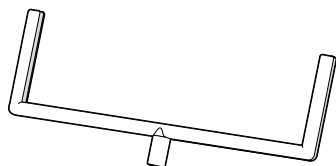

U-FRAME A4 LANDSCAPE

To take tubes Ø 10 mm, to be used with acrylic covers or also suitable for thick and stable carton posters with up to 5 mm thickness. Colors: white, grey, red, silver.

20090-xx

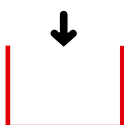

U-FRAME 148 X 210 (SERIES 100)

For posters size A5 landscape or A4 portrait, material thickness max. 2,5 mm, color: white.

11407-xx





The raw material:

Lignin – hidden in every single tree but so far considered as a waste product from the paper industry



The plastic material:

A totally new and innovative BIO granulate – made of over 60% renewable raw material



The result: "Greenline":

The new series made by Oechsle – **best saving of resources!**



The color selection:

- natural off-white (naturally based lignin granulate without color additives): G-01
- organic green (with color additive similar to Pantone 375C): G-375C
- light spruce (with wooden splints in wood finish): G-F-01



SHOWCARD FRAME "GREENLINE"
Trendy showcard frame (series 100) with straight corners made of organic plastics. Short side poster entry. Colors: natural off-white, organic green and light spruce (not A3).

A3		11330-G-xx
A4		11420-G-xx
A5		11520-G-xx

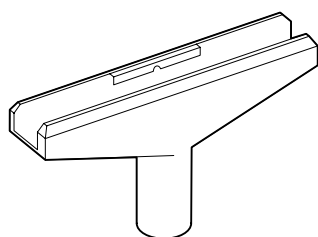

T-PIECE "GREENLINE"
T-piece 90 mm (series 100), colors: natural off-white, organic green.

20011-G-xx



RA "GREENLINE"

Frame base support for showcard frames (series 100) "Greenline", natural off-white.

15° inclined		21760-G-01
upright		21750-G-01



SHOWCARD FRAME SYSTEMS

SHOWCARD STANDS "GREENLINE"

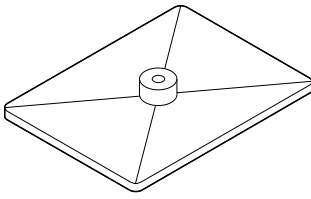

BASE "GREENLINE"

Rectangular base plate made of organic plastics with centred tube holder to take tubes Ø 12 mm. Colors: natural off-white, organic green, light spruce.

20350-G-xx



SHOWCARD STAND "GREENLINE"

Rectangular base made of organic plastics with fixed 310 mm aluminium tube Ø 10 mm, T-piece and showcard frame "Greenline". Colors: natural off-white, organic green.

A5		33515-G-xx
A5 organic green		33515-G-375C
A4		33514-G-xx
A4 organic green		33514-G-375C
A3		33513-G-xx
A3 organic green		33513-G-375C



ACCESSORIES SHOWCARD FRAMES

Offering a vast range of accessories the showcard frames can be fixed in many different ways: easy, fast and safe.

The elements are suitable for the following product lines:
Showcard frames for laminated posters, standard size frames, special size frames, showcard frames DEKOLINE and TWIN-SET (lateral fixing only) as well as price displays. If you need help finding the suitable fixing for your specific requirements, please contact us at any time.

Remark:

For showcard frames size A6 – A3 please use → **accessories series 100.**

For showcard frames size A2 – A1 please use → **accessories series 200.**

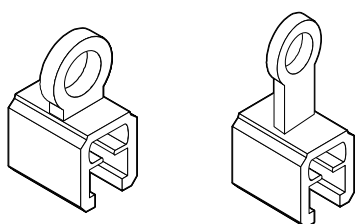

SUSPENSION RING 90°
With ring (Ø 9 mm) to suspend frames 90°, for lateral poster insert, clear.

series 100		21300-00
series 200		22300-00

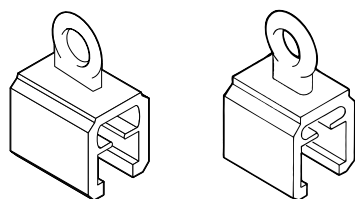

SUSPENSION RING PARALLEL
With ring (Ø 8 mm) to suspend frames parallel, for lateral poster insert, clear.

series 100		21310-00
series 200		22310-00

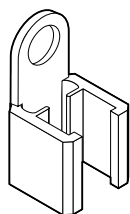

SUSPENSION RING SIDEWAYS (L4)
To suspend frames series 100 with poster insert on top, Ø 9 mm, clear.

21361-00

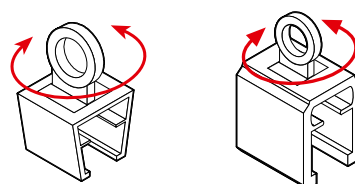

SUSPENSION RING, SWIVEL TYPE
With ring (Ø 8 mm) to suspend frames, rotating in any position, for lateral poster insert, clear.

series 100		21315-00
series 200		22315-00



SHOWCARD FRAME SYSTEMS

ACCESSORIES

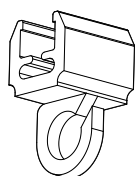

SUSPENSION RING FOR BANNER HANGER R100
Hooks 90° to suspend punched posters, banners, etc., clear.

21333-00

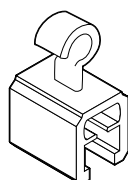
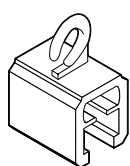

SUSPENSION HOOK, SHORT
With hook to suspend frames with lateral poster insert, for max. Ø 7,5 mm, clear.

series 100 | 21320-00
series 200 | 22320-00

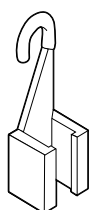
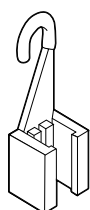

SUSPENSION HOOK (PAIR)
With hook to suspend frames with top poster insert, for max. Ø 6 mm, length hook = 50 mm, clear.

series 100 | 21370-00
series 200 | 22370-00

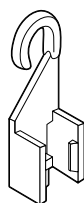

SUSPENSION HOOK SHORT (PAIR)
Short version, with hook to suspend frames series 100 with top poster insert, for max. Ø 6 mm, length hook = 40 mm, clear.

21360-00

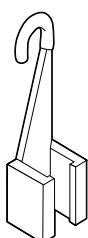

SUSPENSION HOOK (F2-LONG)
To suspend frames series 200 with poster insert on top from tubes Ø 12 mm, length of hook = 58 mm, clear (the same hook is used on right and left hand side).

22371-00

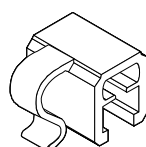

HANGING HOOK
To attach frames to wire baskets etc. with max. Ø 10 mm, for frames with lateral poster insert, clear.

series 100 | 21400-00
series 200 | 22400-00



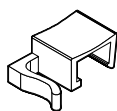

FASTENING CLIP FOR WIRES (PAIR)
To attach frames to wire baskets, shopping trolleys, etc. with max. Ø 6 mm, clear.

series 100 | 21430-00

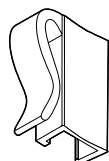

WIRE HOOKS (H4) (PAIR)
For parallel attachment of frames series 100 onto wire shelves, baskets, etc. with max. Ø 10 mm, clear.

21431-00

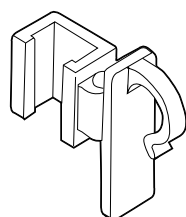

SUSPENSION HOOK, 2-PART (PAIR)
To attach frames series 100 with top poster insert onto wires, etc. with max. Ø 12 mm, grey.

series 100 | 21410-03

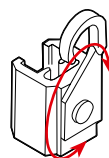

HANGING HOOK SHORT, SWIVEL TYPE (PAIR)
To attach frames with top poster insert to wires etc., with max. Ø 8 mm (series 100) or max. Ø 5 mm (series 200), clear. Length hook: series 100 = 32 mm, series 200 = 50 mm.

series 100 | 21330-00
series 200 | 22350-00

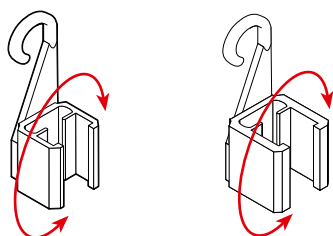

HANGING HOOK BIG, SWIVEL TYPE (PAIR)
To attach frames with top poster insert to wires etc., with max. Ø 10 mm, length hook = 50 mm, clear.

series 100 | 21331-00
series 200 | 22330-00



SHOWCARD FRAME SYSTEMS

ACCESSORIES

SUSPENSION HOOK WIRE, SWIVEL TYPE (PAIR)

To attach frames series 100 with top poster insert onto wires, etc. with max. Ø 7 mm, length of hook = 37 mm, transparent.

21325-00

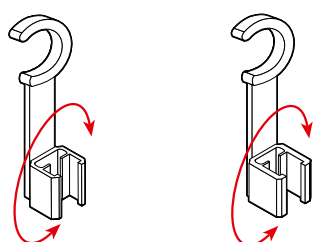

TUBE CLIP, SWIVEL TYPE (PAIR)

To suspend frames from round rails, tubes, etc., with max. Ø 22 mm, length of tube clip = 85 mm, clear.

series 100 | 21610-00
series 200 | 22610-00

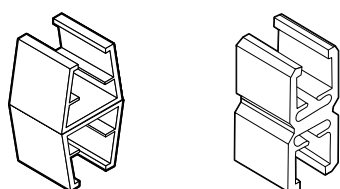

FRAME CONNECTOR

To connect frames of the same series, clear.

series 100 | 21000-00
series 200 | 22000-00

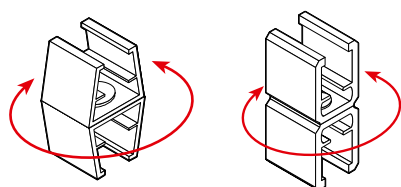

FRAME CONNECTOR SWIVEL TYPE

To connect frames of the same series, rotating, clear.

series 100 | 21010-00
series 200 | 22010-00



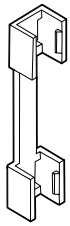

FRAME CONNECTOR PORTRAIT
To connect frames series 100 with top poster insert, length = 64 mm, clear.

21020-00

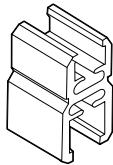

FRAME CONNECTOR
To connect frames series 100 with frames series 200, clear.

21030-00

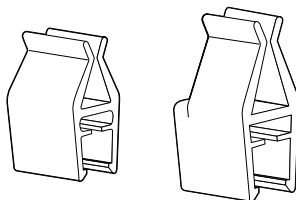
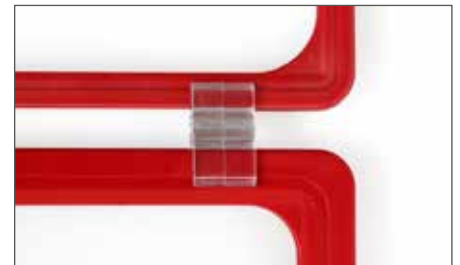

PROMOTION CARD CLIP
To attach posters or signs onto frames, in standing or hanging position, clear.
series 100: poster thickness 0,3 - 1,0 mm,
series 200: poster thickness 0,3 - 2,0 mm

series 100		21920-00
series 200		22920-00

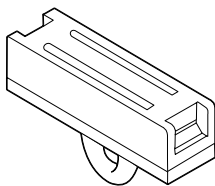

MAGNETIC RING RECTANGULAR
With 1 magnet, for attachment to ceilings, profiles etc., simply suspend frames with hooks, magnetic force up to approx. 2,8 kgs. Size: 44 x 12 mm, Ø ring 8 mm, colors: clear, grey.

20601-xx

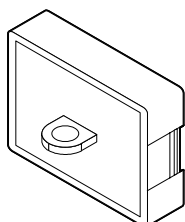

MAGNETIC RING SQUARE
With 2 magnets, for attachment to ceilings, profiles etc., simply suspend frames with hooks, magnetic force up to approx. 5,6 kgs. Size: 36 x 32 mm, Ø ring 8 mm, white.

20602-01



SHOWCARD FRAME SYSTEMS

ACCESSORIES

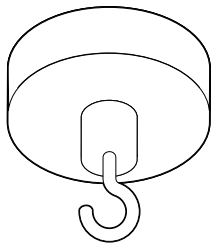

MAGNET FOR CEILING WITH HOOK
To suspend frames, poster rails, poster pockets etc., magnetic force up to approx. 20 kgs (Ø 50 mm) resp. 8 kgs (Ø 32 mm), white.

Ø 32 mm | 20637-01
Ø 50 mm | 20635-01

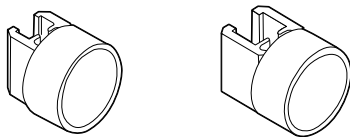

MAGNETIC FASTENER ROUND
For the direct attachment of frames to metallic surfaces, Ø 30 mm, magnetic force up to approx. 4 kgs. For use in refrigerated shelves or cold storage rooms only suitable in glued special version (please indicate when ordering). Colors: OEK standard colors.

series 100 | 21200-xx
series 200 | 22200-xx

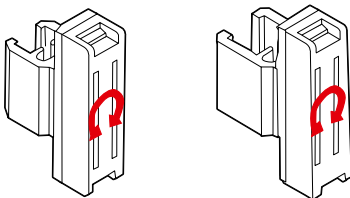

MAGNETIC FASTENER RECTANGULAR, SWIVEL TYPE

With 1 magnet, 360° rotating, magnetic force up to approx. 2,8 kgs. Size: 45 x 12 mm, colors: clear (series 100 also available in grey).

series 100 | 21220-xx
series 200 | 22220-00

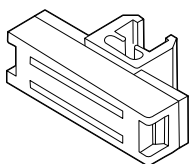

MAGNETIC FASTENER RECTANGULAR
With 1 magnet, in 90° position to frame, magnetic force up to approx. 2,8 kgs. Size: 45 x 12 mm, colors: clear, grey.

series 100 | 21260-xx

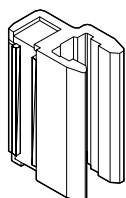

MAGNETIC FASTENER RECTANGULAR (M4)

Magnet with adaptor for parallel fixing of frames series 100 (directly to wall, no distance in between), clear.

21219-00



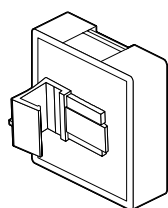

MAGNETIC FASTENER SQUARE, PARALLEL

With 2 magnets, in parallel position to frame, magnetic force up to approx. 5,6 kgs. Size: 36 x 32 mm, color: white (with clear adaptor).

series 100 | 21230-01
series 200 | 22230-01

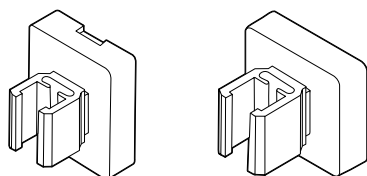

MAGNETIC FASTENER SQUARE, 90°

With 2 magnets, in 90° position to frame, magnetic force up to approx. 5,6 kgs. Size: 36 x 32 mm, color: white (with clear adaptor).

series 100 | 21250-01
series 200 | 22250-01

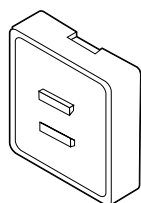

MAGNETIC FASTENER SQUARE, WITHOUT ADAPTOR

With 2 magnets, for variable fixing of the corresponding adaptors (either parallel or 90° version), magnetic force up to approx. 5,6 kgs, white.

21240-01

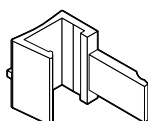

ADAPTOR PARALLEL

For fixing to magnetic fastener, clear.

series 100 | 21231-00
series 200 | 22231-00

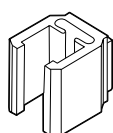

ADAPTOR 90°

For fixing to magnetic fastener, clear.

series 100 | 21251-00
series 200 | 22251-00

SHOWCARD FRAME SYSTEMS

ACCESSORIES

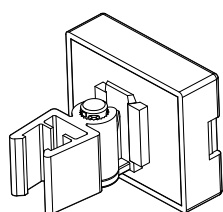

MAGNETIC FASTENER SWIVEL TYPE (MR4)

Square magnet, white, with clear adjustable adaptor, offering different angles for inclined presentation, suitable for frames series 100, magnetic force up to approx. 5,6 kgs.

20377-01

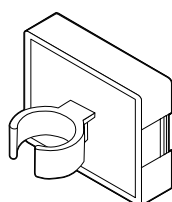

MAGNETIC TUBE CLIP

With 2 magnets, for tubes Ø 12 mm, magnetic force up to approx. 5,6 kgs, size: 36 x 32 mm, white. We recommend to use 2 clips per application.

21255-01

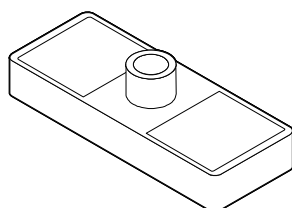

MAGNETIC BASE MF

Plastic base with 4 magnets, magnetic force up to approx. 11 kgs, to take tubes Ø 12 mm, size: 100 x 40 mm, grey.

20370-03

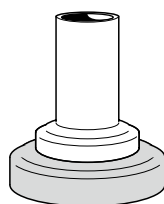

MAGNETIC BASE Ø 50 MM WITH TUBE HOLDER

Round zined magnet, magnetic force up to approx. 18 kgs, with tube holder grey for tubes Ø 12 mm.

20375-03



RETAINING CLIP

To prevent falling out or taking away of posters out of the frames, clear.

series 100 | 21940-00
series 200 | 22940-00



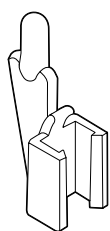

BROWSER CLIP

For swivel mounting of showcard frames series 100, to be used in Infoline models, clear.

21880-00

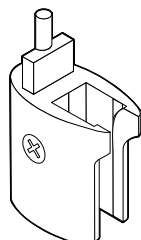

BROWSER CLIP WITH METAL-PIVOT

Very stable, screwed version with metal-pivot for frames series 200, to be used in Infoline models, clear.

22890-00

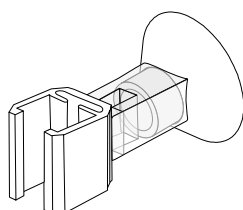

ADHESIVE SUCTION PAD

To attach frames onto glass or smooth surfaces, 2-parts, to be mounted for either parallel or 90° fixing, clear.

series 100 | 21706-00

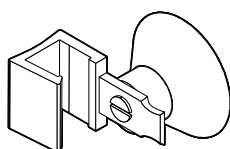

SUCTION PAD PARALLEL

To attach frames onto glass or smooth surfaces, clear.

series 200 | 22705-00

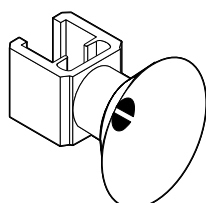

SUCTION PAD 90°

To attach frames onto glass or smooth surfaces, clear.

series 200 | 22700-00



SHOWCARD FRAME SYSTEMS

ACCESSORIES

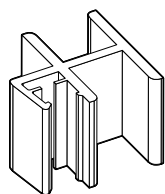

PANEL HANGER

To fix frames series 100 to vertical panels with a thickness of 16 mm, in an either standing or hanging position, clear.

21190-00

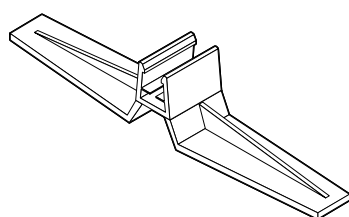

RA1 FRAME BASE SUPPORT

To support frames in an upright position, series 100 1-part, series 200 2-parts, length = 140 mm, clear.

series 100		21750-00
series 200		22750-00

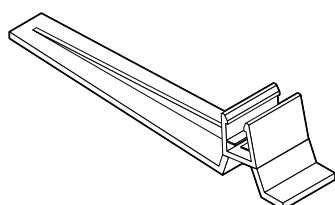
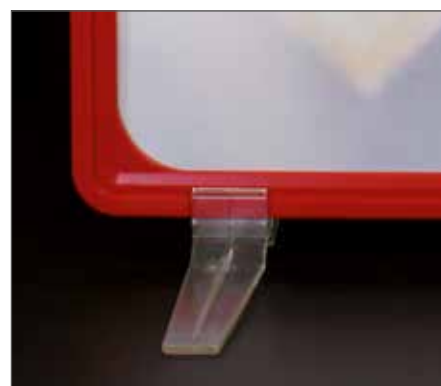

RA2 FRAME BASE SUPPORT

To support frames in a 15° inclined position, series 100 1-part, series 200 2-parts, length = 140 mm, clear.

series 100		21760-00
series 200		22760-00

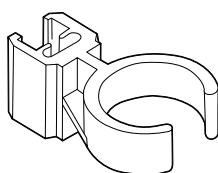
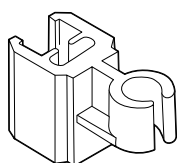

TUBE CLIPS (SERIES 100)

Tube clips to attach frames series 100 to tubes with different diameters. Colors: clear, white.

Ø 8 mm		21508-xx
Ø 10 mm		21510-xx
Ø 12 mm		21512-xx
Ø 14 mm		21514-xx
Ø 18 mm		21518-xx
Ø 22 mm		21522-xx
Ø 28-35 mm		21528-xx
Ø 35-40 mm		21535-xx



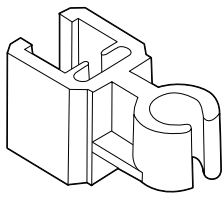

TUBE CLIPS (SERIES 200)

Tube clips to attach frames series 200 to tubes with different diameters. Colors: clear, white.

Ø 10 mm		22510-xx
Ø 12 mm		22512-xx
Ø 14 mm		22514-xx
Ø 16 mm		22516-xx
Ø 20 mm		22520-xx
Ø 22 mm		22522-xx
Ø 28-35 mm		22528-xx

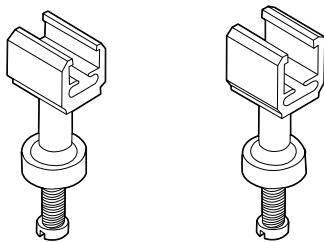

SHELF HOLDER

With internal thread M5 and screw, grey.

series 100		21100-03
series 200		22100-03

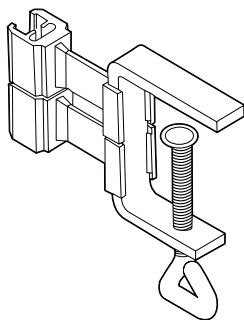

FLEXIBLE CLIP WITH G-CLAMP

To fix frames to shelves, boards, etc., with 1 - 40 mm thickness, not mounted, white.

series 100		21110-26
series 200		22110-26

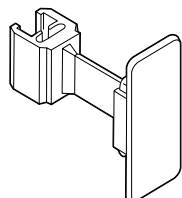

FLEXIBLE CLIP WITH ADHESIVE

To stick frames to smooth surfaces, such as shopping windows, etc., 2-parts not mounted, white. We recommend to use two clips per frame fixing.

series 100		21119-26
series 200		22119-26

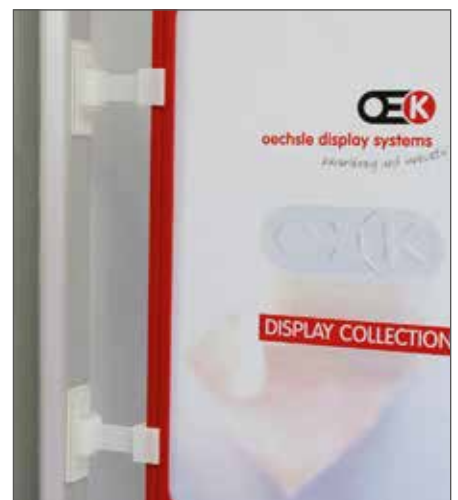

SHOWCARD FRAME SYSTEMS

ACCESSORIES

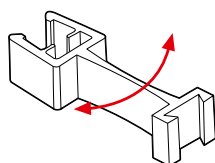

FLEXIBLE CLIP WITH KLICK ADAPTOR
For magnetic fastener series 300, to attach frames series 100 to shelves, etc., white.

21170-26

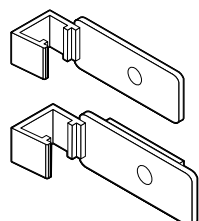

WALL FASTENER SERIES 100
clear

screw mounting | 21130-00
with adhesive | 21131-00

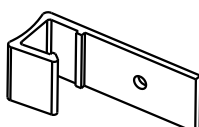

WALL FASTENER SERIES 200
rectangular, clear

screw mounting | 22140-00
with adhesive | 22140-00/K

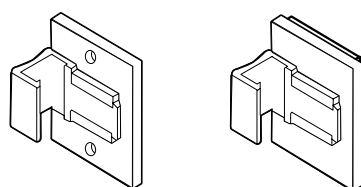

WALL FASTENER SERIES 200
square, clear

screw mounting | 22132-00
with adhesive | 22135-00

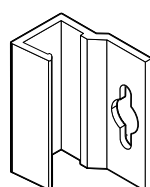

KEYHOLE FASTENER
For parallel fixing of frames series 100 to hooks or screws, clear.

21180-00

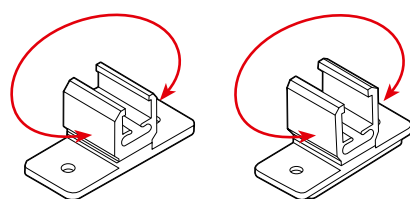

FASTENER WITH ROTARY CLIP
For mounting with screws, or with double adhesive tape, 360° rotating clip, clear.

series 100 (screw mounting) | 21120-00
series 100 (with adhesive) | 21125-00
series 200 (screw mounting) | 22120-00
series 200 (with adhesive) | 22125-00

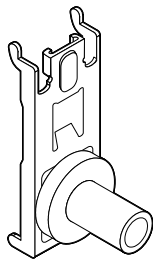

PEG-BOARD CONNECTOR WITH TUBE HOLDER

To attach frames to pegboards with hole centres at 30 mm (corresponds to European standard), plug components zinc-plated with tube holder grey, to fit standard chromium tubes Ø 12 mm.

21720-03

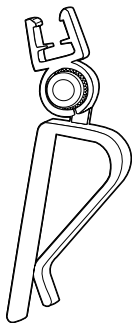

CARDBOARD CLAMP 20

To attach frames onto cartons, baskets and boxes with up to 20 mm thickness, 2-parts, clear.

series 100		21715-00
series 200		22715-00

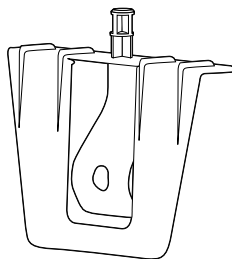

CARDBOARD CLAMP 140 WITH MF CONNECTOR

To attach frames to boxes, fruit baskets or similar with up to 22 mm thickness. Set consisting of clamp 140 black with hinge, MF-connector 50 mm black and T-piece in OEK standard colors.

35550-xx

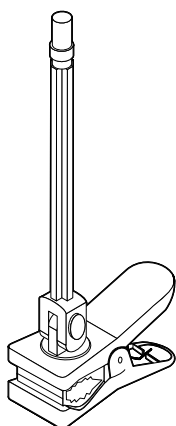

CLAMP ALLROUNDER

Revolving clamp with rod 155 mm, suitable for T-piece Ø 10 mm, clamp range for materials with 8 - 34 mm thickness, with rubber inlay to prevent any scratching. Colors: white, red.

Other colors upon request (e.g. black or grey)

(Showcard frame and T-piece to be ordered separately.)

20560-xx



SHOWCARD FRAME SYSTEMS

ACCESSORIES

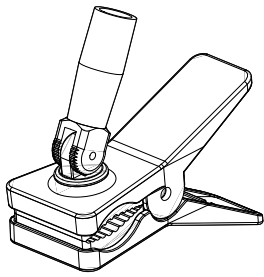

DISPLAY CLAMP TO TAKE TUBES Ø 12 MM
Revolving clamp 360° to take tubes Ø 12 mm. Clamps material between approx. 8-34 mm, plastic with an inside rubber inlay. Colors: white, grey, red.

20580-xx

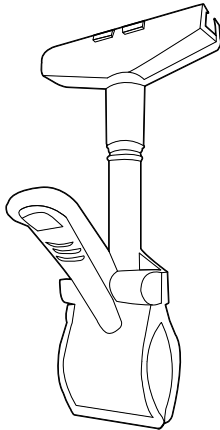

UNIVERSAL CLAMP 25
Very stable clamp for attachment of frames onto textile stands (with oval tubes), baskets, shelves, etc. with material up to max. 25 mm thickness. An inside rubber inlay prevents any scratching and secures a tight fit even on slippery surfaces, supplied with T-piece 70 mm. Made of PC, clear.

20571-00

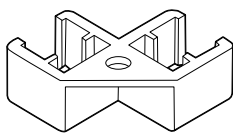

SQUARE HANGER
To connect frames (series 100) at a 90° angle, with hole for suspension cord, clear.

21040-00

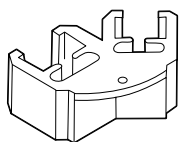

TRIANGULAR HANGER
To connect frames (series 100) at a 60° angle, with hole for suspension cord, clear.

21050-00

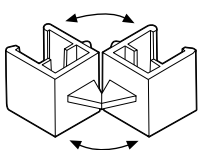

HINGED HANGER
For triangular and square connections, suitable for frames series 200, clear.

22040-00

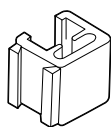

ADAPTOR PARALLEL

For combination of frames series 100 with Klick fasteners (see Klick accessories), clear.

21060-00

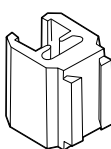

ADAPTOR 90°

For combination of frames series 100 with Klick fasteners (see Klick accessories), clear.

21070-00

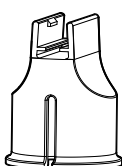

BOTTLE HOLDER

Fitting onto all PET bottles (1,5 L - 1,0 L - 0,5 L), holding showcard frames (series 100), clear.

20025-00

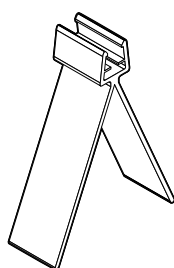

FRAME HOLDER FOR AHT-FREEZERS
Especially to mount frames series 100 to AHT-freezers, for a smart price and information marking, clear.

21770-00



SHOWCARD FRAME SYSTEMS

ACCESSORIES

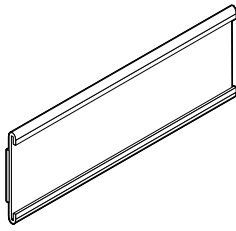

C-RAIL
Plastic profile 28 mm with double adhesive tape, length 2000 mm, white.

21660-01/2000

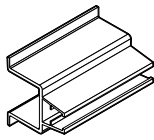

FASTENER 90° FOR C-RAIL
To clamp into C-rail, suits frames series 100, clear.

21663-00

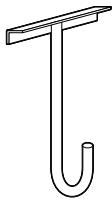

FASTENER FOR PLANT CONTAINER
For plant containers, type "A" for 1 frame, type "B" for 2 frames. T-piece and frame to be ordered separately.

Type "A" | 20550-00
Type "B", available upon request | 20551-00

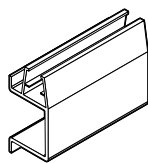

FASTENER PARALLEL FOR C-RAIL
To clamp into C-rail, suits frames series 100, clear.

21665-00

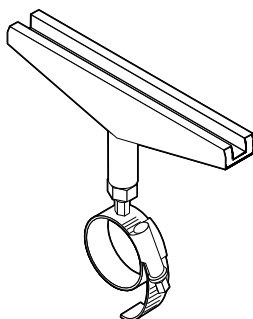

JUBILEE CLIP
To fix frames to tubes with $\varnothing > 25$ mm, jubilee clip zinc-plated with adjustable screw. T-piece to be ordered separately.

\varnothing 25-40 mm | 21740-00
 \varnothing 40-60 mm | 21741-00
 \varnothing 60-80 mm | 21742-00

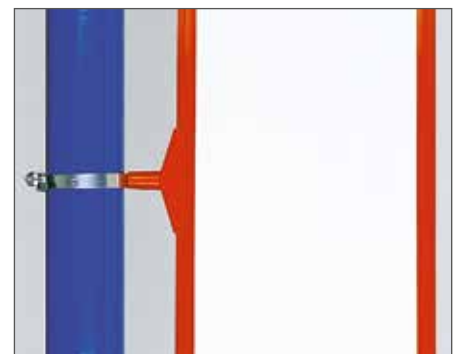

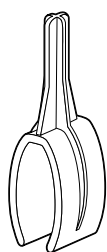

KS 1 OVAL TUBE CLIP

Showcard holder for textiles stand with oval tube 20 x 35 mm, clear. T-piece to be ordered separately.

20530-00



KS 1A FLAT OVAL TUBE CLIP

Showcard holder for textiles stand with flat oval tube 15 x 30 mm, clear. T-piece to be ordered separately.

20531-00

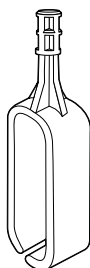

KS 3 OVAL TUBE CLIP

Showcard holder for textiles stand with oval tube 20 x 50 mm, clear. T-piece to be ordered separately.

20534-00

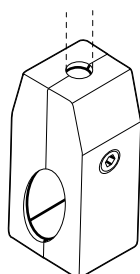

KS 2 O CLAMP FOR OVAL TUBE

Showcard holder for textiles stand with oval tube 20 x 35 mm, very stable and screw fixed, with chromium tube 160 mm, black. T-piece to be ordered separately.

20533-10/160

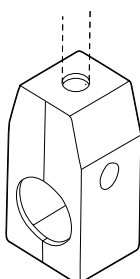

KS 2 R CLAMP FOR ROUND TUBE

Showcard holder for textiles stand with round tube \varnothing 25 mm, very stable and screw fixed, with chromium tube 160 mm, black. T-piece to be ordered separately.

20532-10/160



SHOWCARD FRAME SYSTEMS COMPONENTS

BASES

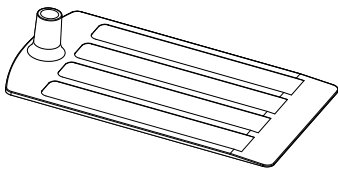

BASE K "ECO"

Rectangular, light weight base made of plastics with tube holder Ø 12 mm. Colors: grey, anthracite and black. Size: 124 x 210 mm.

20348-xx

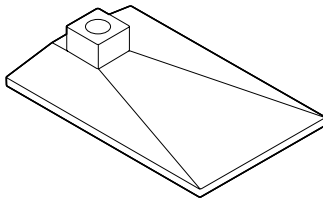

BASE KL

Made of plastics to take tubes Ø 12 mm or Ø 6 mm, colors: white, grey. Size: 140 x 90 mm.

Ø 12 mm | 20380-xx

Ø 6 mm | 20380-xx/12-6

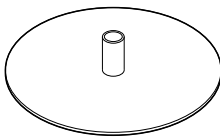

BASE K ROUND

Made of plastics, round, to take tubes Ø 12 mm, colors: white, grey, blue, black. Size: Ø 160 mm, 4 mm thickness.

20340-99/xx

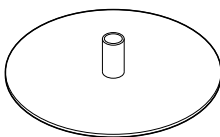

BASE L

Made of plastics with patented Levistor rubber plate sucking to all slippery and smooth surfaces such as glass, to take tubes Ø 12 mm, colors: white, grey, black. Size: Ø 160 mm, 4 mm thickness.

20340-xx

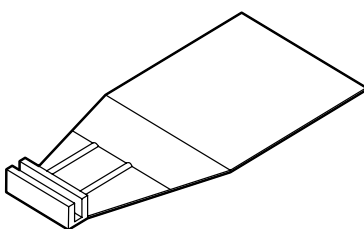

BASE RS 200 X 90 MM

Made of stable plastics to directly hold frames series 100, grey. Size: 200 x 90 mm.

20352-03

Other colors available upon request.



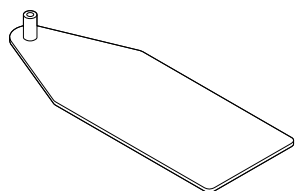

BASE RS
 Made of plastics to take T-piece, not suitable for tubes, in OEK standard colors. Size: 250 x 90 x 3 mm.

20390-xx

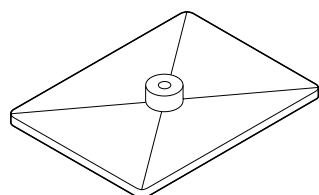
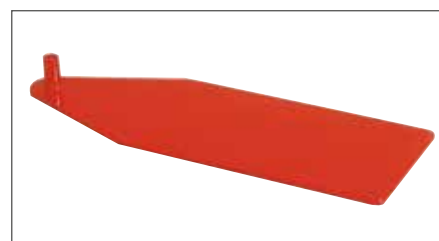

BASE K
 Made of plastics, with centred tube holder to take tubes Ø 12 mm, in OEK standard colors. Size: 200 x 150 mm. Also available with zincd metal inlay.

base K		20350-xx
with metal inlay		20351-xx

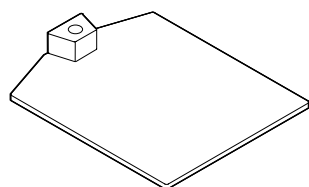
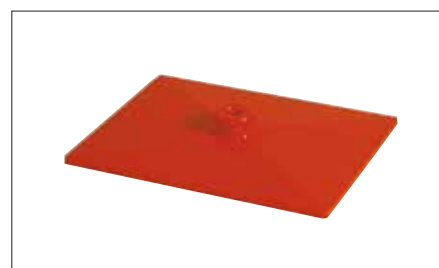

BASE KB
 Made of plastics with zincd metal inlay, to take tubes Ø 12 mm, in OEK standard colors. Size: 200 x 160 x 6 mm.

20360-xx

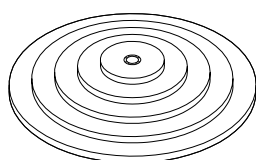

STEPPED BASE DEKO I
 Made of plastics with heavy steel inlay, to take tubes Ø 12 mm or Ø 16 mm. Colors: black, silver. Size: Ø 160 mm.

Ø 16 mm colored		20450-xx
Ø 12 mm colored		20452-xx



PYRAMID BASE DEKO II
 Made of plastics with heavy steel inlay, to take tubes Ø 12 mm or Ø 16 mm. Available color combination (top/ bottom) upon request, size: Ø 160 mm.

Ø 16 mm		20460-xx
Ø 12 mm		20462-xx



SHOWCARD FRAME SYSTEMS COMPONENTS

BASES

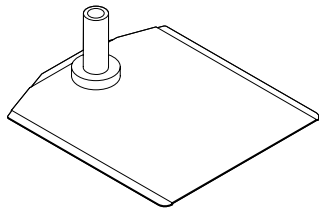

BASE N

Base made of stainless steel with tube holder \varnothing 12 mm made of plastics in OEK standard colors and additional colors.
Size: 185 x 160 x 1,5 mm.

20300-xx

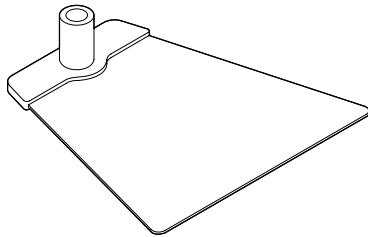
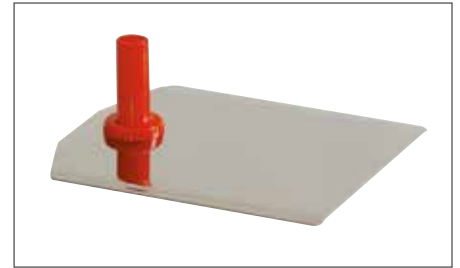

BASE NT

Trapezoid base made of stainless steel with plastic tube holder \varnothing 14 mm or \varnothing 12 mm in OEK standard colors.
Size: 165(80) x 160 x 1,5 mm.

\varnothing 14 mm | 20400-xx
 \varnothing 12 mm | 20401-xx

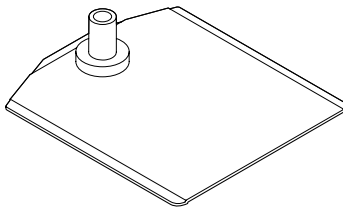

BASE BK

Metal base powder coated grey with tube holder \varnothing 12 mm, grey.
Size: 185 x 160 x 2,5 mm.

20310-03/03

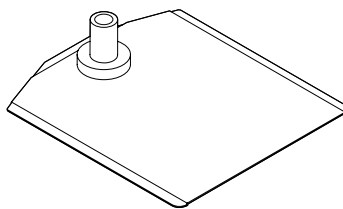

BASE SK

Metal base powder coated black with tube holder \varnothing 12 mm, black.
Size: 180 x 160 x 1,5 mm.

20320-10

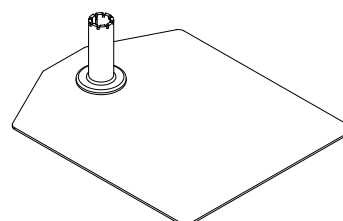

BASE SK ECO

Metal base powder coated available in grey similar RAL 9007 (-9007) with tube holder \varnothing 12 mm in grey or black (-10) with tube holder \varnothing 12 mm in black.
Size: 195 x 160 x 1,5 mm.

20325-xx



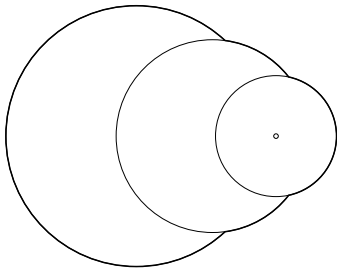

BASE BD

Heavy steel plate without tube holder (are mounted to BD-tubes or supplied for self-mounting), powder coated.
Colors: white, silver-grey, black.

- Ø 160 mm (0,6 kgs): drilling for | 20330-xx
M5, material thickness: 4 mm
(0,6 kg)
- Ø 255 mm (1,2 kg): drilling for | 20331-xx/3
M8, material thickness: 3 mm
(1,2 kg)
- Ø 255 mm (2,0 kgs): drilling for | 20331-xx
M8, material thickness: 5 mm
(2,0 kg)
- Ø 345 mm (3,8 kgs): drilling for | 20334-xx
M8, material thickness: 5 mm
(3,8 kg)

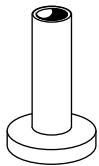
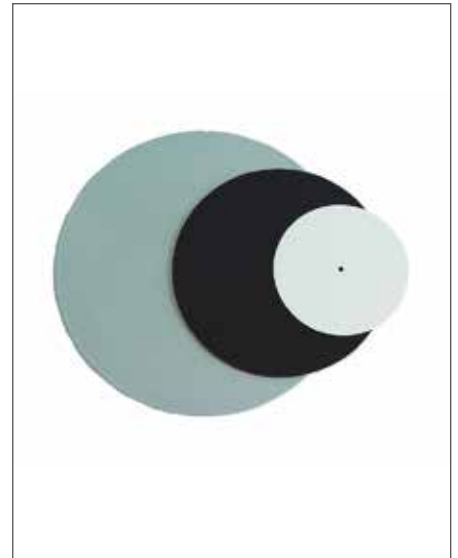

SB TUBE HOLDER FOR TUBES

Ø 12 MM

For self-mounting to bases N, BK, SK, BD
Ø 160 mm, as well as to special devices
with M5 hole, premounted with nut M5
and screw, grey.

20200-03



HEXAGONAL KEY

Hexagonal key to mount SB tube holder,
black.

96-240103

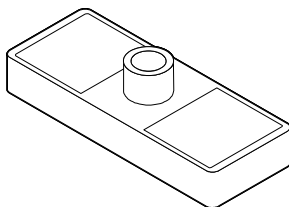

MF MAGNETIC BASE

Plastic base with 2 or 4 magnets, magne-
tic force up to approx. 5,6 kgs or 11 kgs,
to take tubes Ø 12 mm.
Size: 100 x 40 mm, grey.

- 2 magnets | 20372-03
- 4 magnets | 20370-03

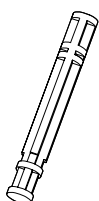

MF CONNECTOR

Made of clear plastics, color black and
anthracite upon request.

- 50 mm | 20170-00
- 75 mm | 20171-00
- 110 mm | 20172-00



SHOWCARD FRAME SYSTEMS COMPONENTS

MAGNETIC FIXINGS

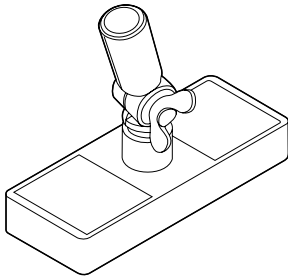

MAGNETIC BASE MF WITH HINGE
Plastic base with 4 magnets, magnetic force up to 11 kgs and hinge grey to take tubes Ø 12 mm, for an inclined tube positioning. Size: 100 x 40 mm.

20373-03



HINGE
Plastic hinge connector between bases with tube holders Ø 12 mm (such as N, BK, SK, L, MF) and tubes Ø 12 mm, for an inclined presentation or to equalise inclined ground, grey.

20271-03



MAGNETIC BASE 60 X 38 MM WITH HINGE

Plastic base with 4 magnets, magnetic force up to approx. 10 kgs, with angle adjustable adaptor to take tubes Ø 10 mm, white.

20378-01

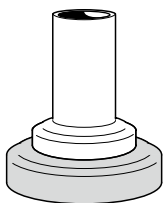

MAGNETIC BASE Ø 50 MM WITH TUBE HOLDER
Round zined magnet, magnetic force up to approx. 18 kgs, with tube holder grey to take tubes Ø 12 mm.

20375-03



MOUNTING SET MAGNET Ø 50
Round zined magnet, magnetic force up to approx. 18 kgs. For a direct attachment onto alu profile frames or customized solutions.

21450-00-E



SHOWCARD FRAME SYSTEMS COMPONENTS

VARIOUS COMPONENTS/TUBES

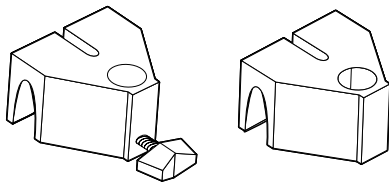

SHOWCARD HOLDER DK (PAIR)
 DK holder (pair) grey, suitable for wires with \varnothing 4 - 8 mm and a vertical wire distance of min. 18 mm, suitable for chromium tubes with \varnothing 12 mm.

20545-03



PALLET CLAW
 To attach onto Euro and Chep pallets, made of zinc coated metal to hold tubes \varnothing 12 mm.

for Euro pallets		90-39040
for Chep pallets		90-39020



FIXED CHROMIUM TUBE
 Fixed chromium tube, top with reduced diameter, top \varnothing : 10 mm, bottom \varnothing : 12 mm. Also available with external threaded bolt M8 or M10.

160 mm		20100-35/0160
310 mm		20100-35/0310
410 mm		20100-35/0410
600 mm		20100-35/0600



ADJUSTABLE CHROMIUM TUBE
 Adjustable chromium tube, inner tube \varnothing : 10 mm, outer tube \varnothing : 12 mm. Also available with external threaded bolt M8 or M10.

320-620 mm		20140-35/-0620
450-900 mm		20140-35/-0900
600-1200 mm		20140-35/-1200



SHOWCARD FRAME SYSTEMS COMPONENTS

TUBES

ADJUSTABLE CHROMIUM TUBE WITH LEVER CLAMP

Adjustable chromium tube 320 - 620 mm with plastic lever clamp grey, inner tube Ø: 10 mm, outer tube Ø: 12 mm.

20144-03/-0620



ADJUSTABLE ALUMINIUM TUBE

Adjustable aluminium tube with screw connector grey, inner tube Ø 9 mm, outer tube Ø: 12 mm.

320-620 mm		15800-91/03/-0620
500-1000 mm		15800-91/03/-1000



ADJUSTABLE PLASTIC TUBE

Adjustable plastic tube (glass-fiber reinforced) with screw connector, black. Inner tube Ø: 9 mm, outer tube Ø: 12 mm (to use with T-pieces Ø: 9 mm).

adj. 320 - 620 mm		20160-10/-0620
adj. 620 - 1200 mm		20160-10/-1200
adj. 820 - 1600 mm		20160-10/-1600

Adjustable plastic tube (glass-fiber reinforced) with bolt, to use with T-pieces Ø: 10 mm.

adj. 320 - 620 mm | 20161-10/-0620 B



PLASTIC TUBE NT

Adjustable plastic tube 320 - 620 mm, white with tube fixing in OEK standard colors, inner tube Ø: 10 mm, outer tube Ø: 14 mm.

20167-01/xx

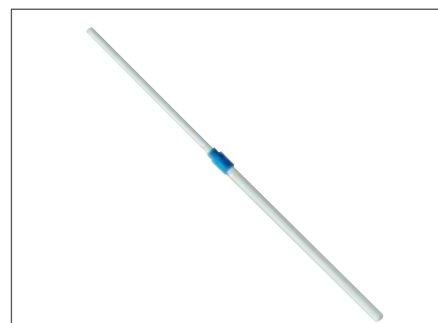

DEKOLINE TUBE

Fixed aluminium tube Ø 16 mm, length 320 mm, suitable for DEKO-T-pieces only.

anodized aluminium		15710-91/0320
black		15710-10/0320
white		15710-01/0320



TWINSET TUBE

Fixed aluminium tube \varnothing 16 mm, length 320 mm, with bolt on top (\varnothing 10 mm), to take TWINSET basic frame (with lower section).

anodized | 15712-91/0320

aluminium

black | 15712-10/0320

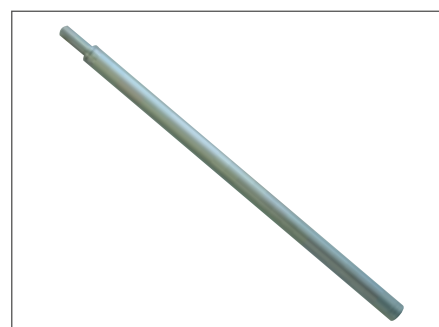
**CHROMIUM TUBE BD 1000-1700 MM**

Adjustable chromium tube, with bolt on top (\varnothing 10 mm) to take T-piece, mounted with tube holder in white, silver-grey or black. Suitable only for BD bases \varnothing 255 mm and \varnothing 350 mm. Inner tube \varnothing : 15 mm, outer tube \varnothing : 18 mm.

20176-xx

**ALUMINIUM TUBE BD 1000-1900 MM**

Adjustable aluminium tube, with bolt on top (\varnothing 10 mm) to take T-piece, mounted with tube holder in white, silver-grey or black. Suitable only for BD bases \varnothing 255 mm and \varnothing 345 mm. Inner tube \varnothing : 16 mm, outer tube \varnothing : 20 mm.

15736-91/-1900/xx

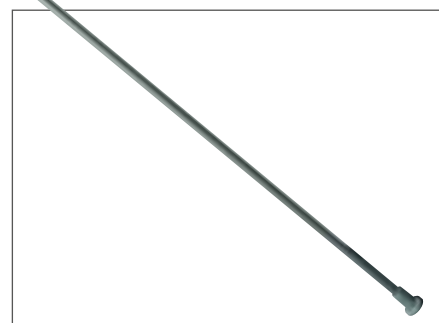

SHOWCARD FRAME SYSTEMS COMPONENTS

T-PIECES

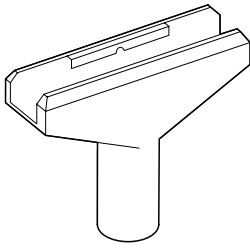

T-PIECE 60 MM (SERIES 100) Ø 10 MM
Recommended for frames A6 - A5,
colors: OEK standard colors, clear.

20010-xx

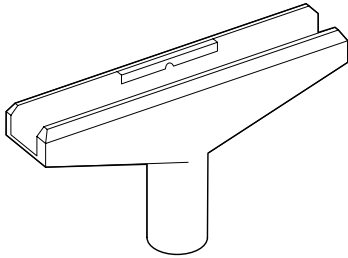

T-PIECE 90 MM (SERIES 100) Ø 10 MM
Recommended for frames A4 - A3,
colors: OEK standard colors, additional
colors, clear, metallic silver, silver,
chromium.

20011-xx

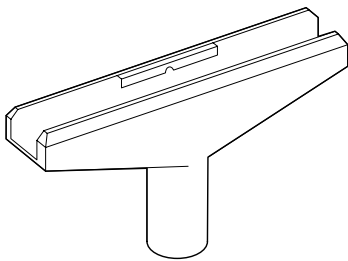

T-PIECE 90 MM (SERIES 100) Ø 9 MM
Recommended for frames A4 - A3 and
suitable only for Alu-tube adjustable
Ø 9 mm,
colors: clear, black.
Other colors: upon request.

20011-xx/09

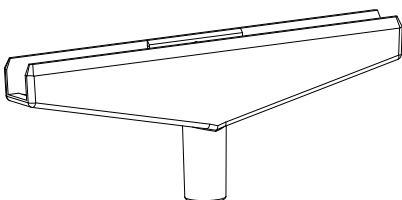

T-PIECE 160 MM Ø 10 MM
Recommended for larger frame sizes,
colors: OEK standard colors, clear,
silver (series 200 only).

(series 100), colored | 20012-xx
(series 200), colored | 20022-xx

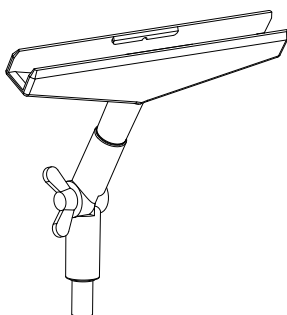

HINGE FOR T-PIECE
Hinged connector between tube (top Ø:
10 mm) and T-piece (upper hinge part Ø
12 mm with MF connector 50 mm), for
inclined presentation of showcard frames.
Made of grey plastics.

20269-03



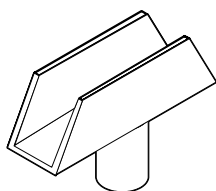

T-PIECE 550

Suits profile frames (series 500) such as Woodline and alu-profile frames, to fit onto tubes Ø 16 mm or Ø 10 mm, length 100 mm.

Colors: clear, white, grey, red, black.

Ø 10 mm		20053-xx
Ø 16 mm		20050-xx

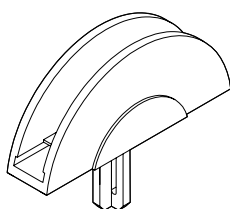

DEKO T-PIECE SEMICIRCULAR

Fits aluminium tubes Ø 16 mm, series 100. Colors: OEK standard colors, silver, chrome.

20040-xx

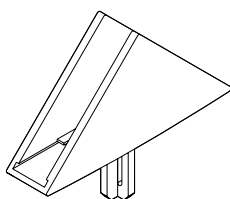

DEKO T-PIECE TRIANGULAR

Fits aluminium tubes Ø 16 mm, series 100. Colors: OEK standard colors, silver, chrome.

20041-xx

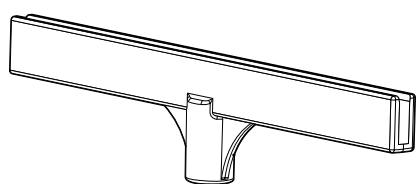

HOLDER FOR ACRYLIC COVER

Suits onto tubes Ø 10 mm, to hold acrylic covers (with bending on top). For inserting 2 posters or papers with up to max. 120g/sqm each. Colors: clear, (holder 210 also in chrome).

Holder 150		20061-00
Holder 210		20060-xx

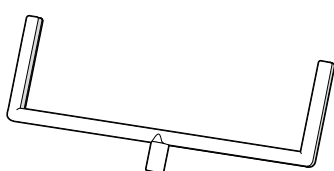

U-FRAME A4 LANDSCAPE

To take tubes Ø 10 mm, to be used with acrylic cover, bent edge preferable at the bottom. Thus posters with advertising crowners and toppers can be easily inserted. Also suitable without acrylic cover: for thick and stable carton posters with up to 5 mm.

Colors: white, grey, red, silver.

20090-xx



SHOWCARD FRAME SYSTEMS COMPONENTS

ACRYLIC COVERS/-HOLDERS

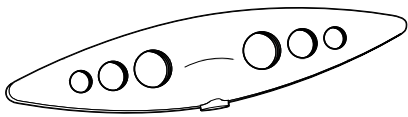

HOLDER ONDA

Elegant plastic support for acrylic cover, suits tubes Ø 10 mm. Colors: grey, red, ultramarine blue, silver.

20080-xx

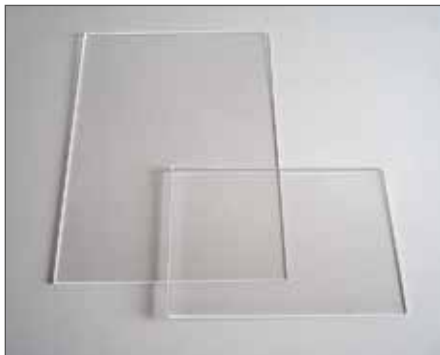

ACRYLIC COVER

Suits into holder ONDA and holder 150 resp. 210, bent acrylic, 2 mm thickness, total thickness: 4 mm (bent: 2 x 2 mm), clear.

A6 portrait		27100-A6/20
A5 portrait		27100-A5/20
A5 landscape		27101-A5/20
A4 portrait		27100-A4/20
A4 landscape		27101-A4/20

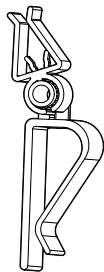

CARDBOARD CLAMP 20 FOR ACRYLIC COVER

Suitable for acrylic covers with 3,5 - 4,5 mm thickness. To attach onto boxes, trays, etc. with material of up to max. 20 mm thickness, clear. We recommend to use 2 clamps per acrylic cover.

24715-00

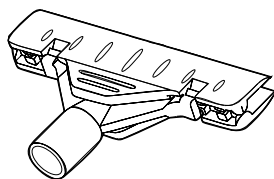

CLAMPHOLDER FOR TUBES

Clampholder made of clear plastics with 100 mm wide clamp to take cards, posters or signs with up to 5 mm thickness, to fit onto tubes with Ø 10 mm.

17050-00

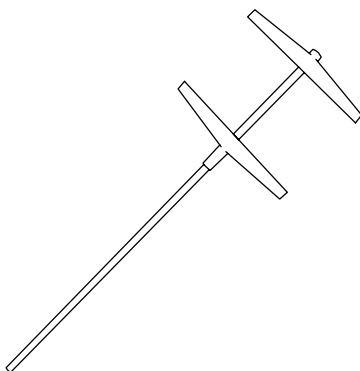

HOLDER FL

Plastic holder FL to take tubes Ø 10 mm, with FL rod adjustable up to 470 mm, to hold posters up to size A3, double sided. Colors: white, grey, chrome.

Suitable chromium tubes to be ordered separately.

20190-xx



SHOWCARD FRAME SYSTEMS COMPONENTS

VARIOUS ACCESSORIES

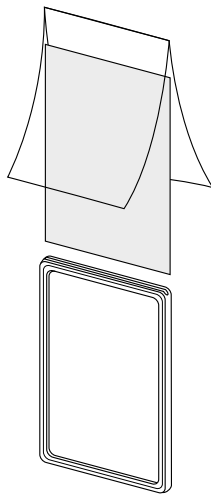

PVC POSTER PROTECTORS

Suitable for showcard frames of same size, folded short side, made of non-reflective, clear PVC.

A6 (0,2 mm)		29100-A6/02
A5 (0,2 mm)		29100-A5/02
A4 (0,2 mm)		29100-A4/02
A3 (0,3 mm)		29100-A3/03
A2 (0,3 mm)		29100-A2/03
A1 (0,4 mm)		29100-A1/04



PVC CUTTING

Suitable for showcard frames of same size, material thickness depending on size 0,2 mm (A6 - A3) and 0,5 mm (A2 - A0 and 50 x 70 cm, as well as 70 x 100 cm), made of non-reflective, clear PVC.

A6		29000-A6/02
A5		29000-A5/02
A4		29000-A4/02
A3		29000-A3/02
A2		29010-A2/05
A1		29010-A1/05
A0		29010-A0/05
50 x 70 cm		29010-B2/05
70 x 100 cm		29010-B1/05

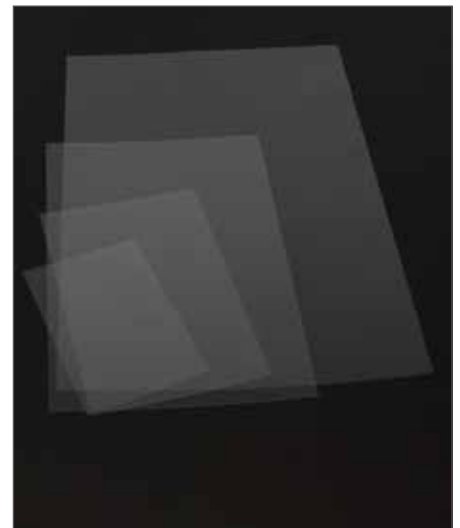

CHALK BOARD

Made of polystyrene, both sides slate coated, for showcard frames of same size, thickness 1 mm, rounded edges, black.

Material thickness: A8 - A3: 0,95 mm.
A2, A1, 50 x 70 cm and 70 x 100 cm: 1,5 mm.

Further sizes upon request.

A8		30012-A8/095
A7		30012-A7/095
A6		30012-A6/095
A5		30012-A5/095
A4		30012-A4/095
A3		30012-A3/095
A2 (1,5 mm)		30012-A2/15
A1 (1,5 mm)		30012-A1/15
50 x 70 cm (1,5 mm)		30012-B2/15
70 x 100 cm (1,5 mm)		30012-B1/15



Please note: These chalk boards are not heat-resistant. An exposure to direct sun light for example may lead to a deformation of the boards. For heat-resistant chalk boards see page 194.

SHOWCARD FRAME SYSTEMS COMPONENTS

VARIOUS ACCESSORIES

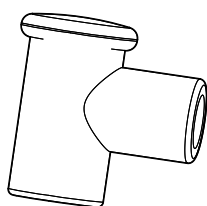

GALLOW CORNER CONNECTOR
Corner connector for chromium tubes to be used as gallow stand.
Colors: white and grey.

12 mm / 10 mm | 20262-xx
10 mm / 10 mm | 20263-xx

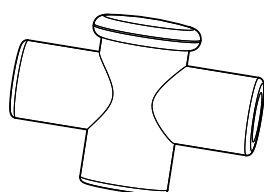

GALLOW T-CONNECTOR
T-connector for chromium tubes to be used as gallow stand.

12 mm / 10 mm | 20260-03
10 mm / 10 mm | 20261-03



GALLOW END CAP Ø 10 MM
End Cap for tubes Ø 10 mm, grey.

20264-03



EXTRA

For your EXTRA a piece of extra information!

Especially if used for fashion this display cuts a good figure. But also for other uses where several pieces of price information need to be displayed in a space saving manner, the EXTRA holder is of big help.

Combined with the Klick accessories (series 300) it can be used as support and variable stand in shopping windows, but also for shelves and slat walls.



EXTRA WITH KL BASE

KL base grey, with aluminium tube Ø 6 mm, in 200 and 400 mm lengths with swivel-type Klick adaptor (to adjust viewing angle) and label holder EXTRA, grey.

EXTRA 200 with KL base | 36600-03/200
EXTRA 400 with KL base | 36600-03/400



KL STAND

KL base grey, with aluminium tube Ø 6 mm, in 200 and 400 mm lengths with swivel-type Klick adaptor. To take Klick barkers, cardholders etc. (please order separately).

KL stand 200 | 38400-91/6/200
KL stand 400 | 38400-91/6/400



CARDHOLDER WITH KL BASE

KL base grey, with aluminium tube Ø 6 mm in 200 and 400 mm lengths and cardholder grey. (adjustable viewing angle)

Cardholder 200 with KL | 36100-03/200
base
Cardholder 400 with KL | 36100-03/400
base



SHOWCARD FRAME SYSTEMS

SHOWCARD STANDS

SHOWCARD STAND K "ECO"

Rectangular, light weight base made of plastics in grey or dark grey, aluminium tube adjustable with grey tube fixing, T-piece Ø 9 mm clear. Frames to be ordered separately.

Please note: to be put underneath pallets or needs to be charged by an additional weight when standing free.

adjustable - 620 mm		34224-xx/-620
adjustable - 1000 mm		34224-xx/-1000



SHOWCARD STAND K

Rectangular base made of plastics, chromium tube Ø 12 mm, adjustable 320 - 620 mm, frame, T-piece and base in OEK standard colors.

A very popular stand with unbreakable plastic base and centered tube position.

Also available with fixed chromium tube 310 mm (see price list).

On request K-base can be supplied with metal inlay as heavy version.

A5		33525-xx
A4		33524-xx
A3		33523-xx



SHOWCARD STAND K ROUND

Round base Ø 160 mm made of white plastics, chromium tube Ø 12 mm, adjustable 320 - 620 mm, frame, T-piece and base in OEK standard colors. With white, grey and black frames also the base will be supplied in the same color.

A5		33535-xx
A4		33534-xx
A3		33533-xx



SHOWCARD FRAME SYSTEMS

SHOWCARD STANDS

Depending on the size of the showcard frame, the length of the tube and the conditions on site we recommend putting some extra weight on the showcard base for maximum stability.



SHOWCARD STAND L

Round base Ø 160 mm made of white plastics with patented "Levistor" rubber plate, chromium tube Ø 12 mm, adjustable 320 - 620 mm, frame and T-piece in OEK standard colors. With grey and black frames also the base will be supplied in the same color.

With patented "Levistor" rubber plate underneath, sucking to all smooth surfaces. Thus being especially suitable for sales desks and glass shelves.

Also available with fixed chromium tube 310 mm (see price list).

A5		33425-xx
A4		33424-xx
A3		33423-xx
A2		33422-xx



SHOWCARD STAND KB

Rectangular base made of plastic with galvanised metal inlay, chromium tube Ø 12 mm, adjustable 320 - 620 mm, frame, T-piece and base in OEK standard colors.

Plastic base with metal inlay for high stability.

Also available with fixed chromium tube 310 mm (see price list).

A5		33625-xx
A4		33624-xx
A3		33623-xx
A2		33622-xx



SHOWCARD STAND NT WITH PLASTIC TUBE

Trapezoid shaped stainless steel base, white plastic tube Ø 14 mm, adjustable 320 - 620 mm, frame, T-piece, tube fixing and holder in OEK standard colors.

With plastic tube and colored tube fixing, especially suitable for outdoor use and humid areas.

A5		34085-xx/01
A4		34084-xx/01
A3		34083-xx/01

SHOWCARD FRAME SYSTEMS

SHOWCARD STANDS

Depending on the size of the showcard frame, the length of the tube and the conditions on site we recommend putting some extra weight on the showcard base for maximum stability.

SHOWCARD STAND NT WITH CHROMIUM TUBE

Trapezoid shaped stainless steel base, chromium tube Ø 12 mm, adjustable 320 - 620 mm, frame, T-piece and tube holder in OEK standard colors.

A5		34055-xx
A4		34054-xx
A3		34053-xx



SHOWCARD STAND N

Rectangular stainless steel base, chromium tube Ø 12 mm, adjustable 320 - 620 mm, frame, T-piece and tube holder in OEK standard colors and all additional colors.

With base made of stainless steel for a secure stand.

Also available with fixed chromium tube 310 mm (see price list).

A5		33045-xx
A5 chromium		33045-35
A4		33044-xx
A4 chromium		33044-35
A3		33043-xx
A3 chromium		33043-35



SHOWCARD STAND BK

Rectangular, plastic-coated metal base in grey, chromium tube Ø 12 mm, adjustable 320 - 620 mm with lever clamp and tube holder in grey, frame and T-piece in OEK standard colors.

With stable lever clamp especially recommended for larger and heavier frames.

A5		33155-xx
A4		33154-xx
A3		33153-xx
A2		33152-xx



SHOWCARD FRAME SYSTEMS

SHOWCARD STANDS

Depending on the size of the showcard frame, the length of the tube and the conditions on site we recommend putting some extra weight on the showcard base for maximum stability.

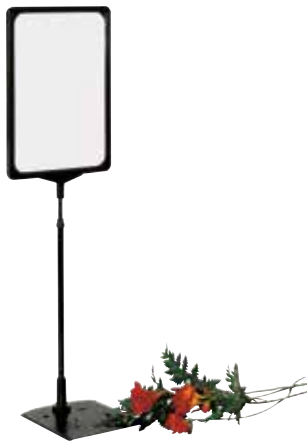

SHOWCARD STAND SK

Rectangular, powder-coated metal base in black, glass-fibre reinforced plastic tube black, adjustable 320 - 620 mm with tube holder in black, frame and T-piece in OEK standard colors.

A5		33265-xx
A4		33264-xx
A3		33263-xx



With black, glass-fibre reinforced plastic tube especially resistant to corrosion. Therefore ideal for the use in areas with high humidity such as garden centres or cold storage rooms.

SHOWCARD STAND SK ECO

Rectangular, powdercoated metal base, base available either black (-10) with tube holder Ø 12 mm black or base grey (similar to RAL 9007) with tube holder Ø 12 mm grey, each version with plastic tube adjustable 320 - 620 mm, black, T-piece and standard frame in OEK standard colors.

A5		33565-xx
A4		33564-xx
A3		33563-xx



SHOWCARD STAND SK LAMINATE

Rectangular, powder-coated metal base in black, glass-fibre reinforced plastic tube black, adjustable 320 - 620 mm with tube holder in black, frame for laminated posters and T-piece in OEK standard colors.

A5		33275-xx
A4		33274-xx
A3		33273-xx



SHOWCARD FRAME SYSTEMS

SHOWCARD STANDS

Depending on the size of the showcard frame, the length of the tube and the conditions on site we recommend putting some extra weight on the showcard base for maximum stability.



This model offers you a maximum of flexibility in presentation – independent from any standard sizes and frames.

SHOWCARD STAND FL

Rectangular stainless steel base with tube holder grey, chromium tube, adjustable 320 - 620 mm, FL-holder chromium plated with FL rod adjustable up to 470 mm, to take 2 posters (back to back) with 2 mm thickness each and 120 - 420 mm height (up to size A3).

34707-35

Choose your preferred base and tube (listed in chapter components) and combine it with the FL holder – and even your most individual requirements will be realized.

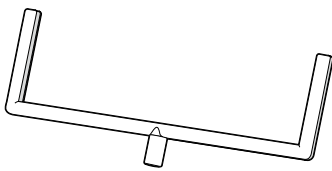

ACRYLIC SHOWCARD STAND U-FRAME

U-frame A4 landscape with acrylic cover, fixed chromium tube 310 mm, rectangular K base. Colors: white, grey, red, silver.

35051-xx



ACRYLIC SHOWCARD STAND ONDA

Acrylic cover A4 portrait or A5 landscape with plastic ONDA holder, fixed chromium tube 310 mm, pyramid base Ø 160 mm. Colors: grey, red, ultramarine blue, silver.

A5 landscape		35062-xx
A4 portrait		35061-xx



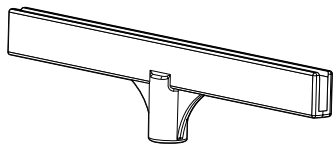

ACRYLIC SHOWCARD STAND K
Round K base clear, MF rod 75 mm, holder 150 resp. 210 with acrylic cover A5 resp. A4 portrait, clear.

A5		33505-00
A4		33504-00



ACRYLIC SHOWCARD STAND N
Rectangular N base with clear tube holder, adjustable chromium tube 320 - 620 mm, holder 150 resp. 210 with acrylic cover A5 resp. A4 portrait.

A5		33005-00/-620
A4		33010-00/-620



SHOWCARD STAND TWIN-SET WITH PYRAMID BASE

Consisting of pyramid base Deko II, aluminium tube Ø 16 mm fixed 320 mm, lower section and Twin-Set basic frame.

Basic frame, lower section and pyramid base to be combined in different colors individually. Available color varieties upon request.

34346-xxxx



SHOWCARD STAND TWIN-SET WITH K BASE

Rectangular plastic base in OEK standard colors, adjustable chromium tube 320 - 620 mm, TWIN-SET basic frame (without lower section). Colors: white, grey, yellow, red, green, blue, black, darkblue.

34335-xx

SHOWCARD FRAME SYSTEMS

SHOWCARD STANDS

SHOWCARD STAND DEKO I BLUE

Consisting of stepped base black, fixed aluminium tube 320 mm Ø 16 mm, DEKO T-piece semi-circular blue, DEKO frame black.

Available upon request for the following sizes:

A5		34505-10/08
A4		34504-10/08
A3		34503-10/08



SHOWCARD STAND DEKO II YELLOW

Consisting of pyramid base black/yellow, fixed aluminium tube 320 mm, Ø 16 mm black, DEKO T-piece triangular yellow, DEKO frame black.

Available upon request for the following sizes:

A5		34605-10/04
A4		34604-10/04
A3		34603-10/04



SHOWCARD FRAME SYSTEMS
FLOOR STANDING STANDS



SHOWCARD STAND BD-MINI
BD base Ø 160 mm silver-grey, chromium tube adjustable 600 - 1200 mm with lever clamp, T-piece and frame in OEK standard colors.

A4		33284-xx
A3		33283-xx



SHOWCARD STAND BD-ECO
BD base Ø 255 mm silver-grey, chromium tube adjustable 800 - 1600 mm with lever clamp, T-piece and frame in OEK standard colors.

A4		33294-xx
A3		33293-xx
A2		33292-xx



MODEL BD
BD base Ø 255 mm white, chromium tube adjustable 1000 - 1700 mm, T-piece and frame in OEK standard colors. With frames in grey, black and silver the base will be also supplied in the same color.

A4		33314-xx
A4 silver		33314-30
A3		33313-xx
A3 silver		33313-30
A2		33312-xx
A2 silver		33312-30



MODEL BD-DEKO
BD base Ø 255 mm black, aluminium tube 900 mm fixed or adjustable 1000-1900 mm with black hinge, DEKO-T-piece triangular and frame in OEK standard colors.

A4 fixed		33344-xx
A4 adjustable		33344-xx/-1900
A3 adjustable		33343-xx/-1900



SHOWCARD FRAME SYSTEMS

FLOOR STANDING STANDS

ACRYLIC SHOWCARD STAND BD
BD base Ø 160 mm silver-grey, adjustable
chromium tube 320 - 620 mm with lever
clamp, holder 210 with acrylic cover A4
portrait.

33342-03/00/-620



LEAFLET HOLDER A4 (SET)

Fitting to the showcard stand model BD
(3331x-xx) or to tubes Ø 15 mm, made of
polystyrene, clear. Depth: 40 mm. For
more acrylic products please see page 169.

32414-00/35



SHOWCARD FRAME SYSTEMS

GALLOW STANDS

ALU-BD "FLAG"

BD base Ø 345 mm silver-grey, aluminium tube adjustable 1000 - 1900 mm, with 2 tube clips Ø 16 mm clear and showcard frame A2 in OEK standard colors.

33352-33/-1900/xx



ALU-BD WITH FLAG SUSPENSION

BD base Ø 255 mm silver-grey, aluminium tube adjustable 1300 - 2500 mm with special bolt to suspend flags, banners or similar.

33353-33/-2500/33

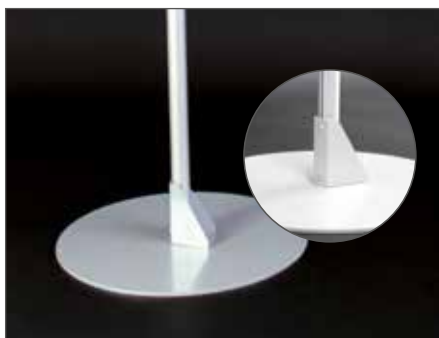

GALLOW SHOWCARD STAND QP (REINFORCED FIXED)

BD-base Ø 350 mm silver grey with support plate, qP alu tube fixed 2000 mm, gallow pre-mounted with gusset plate, two grey end caps and 2 suspension hooks qP (transparent), incl. screws and hexagonal key.

with 1 gallow | 38790-91/1900/0700
L = 700 mm (for A1)

with 1 gallow | 38790-91/1900/0550
L = 550 mm (for A2)



SHOWCARD FRAME SYSTEMS

GALLOW STANDS

GALLOW SHOWCARD STAND ALU BD (FIXED)

BD base Ø 255 mm silver-grey, fixed aluminium tube 1600 mm with 1 or 2 gallows Ø 20 mm, length 400 mm (without frame and tube clips).

with 1 gallow | 38410-33/1600
with 2 gallows | 38420-33/1600

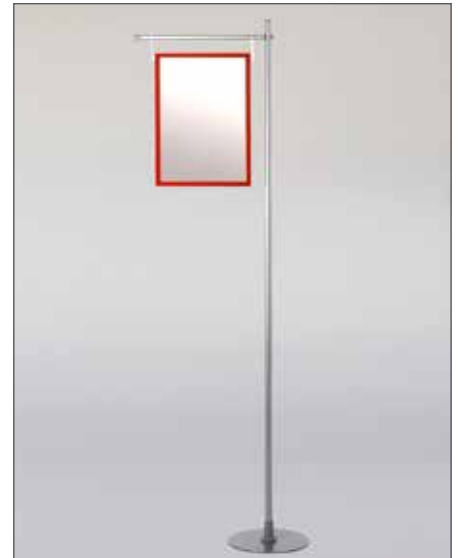

GALLOW SHOWCARD STAND ALU BD (ADJUSTABLE)

BD base Ø 255 mm silver-grey, aluminium tube adjustable 1000-1900 mm, with 1 or 2 gallows Ø 16 mm, length 400 mm (without frame and tube clips).

with 1 gallow | 38411-33/-1900
with 2 gallows | 38421-33/-1900



GALLOW SHOWCARD STAND SQUARE PROFILE

Heavy steel base 300 x 300 mm silver grey, square-profiled tube 1200 mm with inner tube adjustable up to a total length of 2100 mm, gallow square profile 10 x 10 mm, length 500 mm (frame and suspension hooks to be ordered separately). Suitable fastening elements (series 100).

38760-33/-2100





SHOWCARD STAND CH

Plastic base round Ø 160 mm grey with chromium tube fixed 310 mm or adjustable 320-620 mm with lever clamp and clampholder, width 100 mm, clear.

fixed		33419-35/310
adjustable		33429-35/310-620

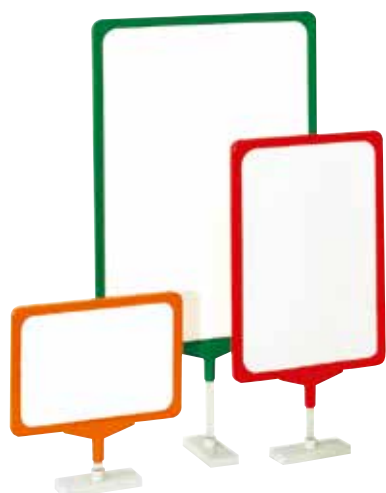

The plastic base with its 4 magnets can be used for a variety of applications. According to the size of the frame and the type of application you can choose between 3 different lengths of MF connectors made of plastics.

SHOWCARD HOLDER MF

Magnetic base with 4 magnets, grey. Size: 100 x 40 cm, MF-Connector clear, Ø bottom: 12 mm, Ø top: 10 mm (not mounted).

50 mm		20370-03/00/050
75 mm		20370-03/00/075
110 mm		20370-03/00/110

With frame sizes larger than A3 we recommend to use 2 magnetic bases. Please order showcard frames and T-piece separately.

SHOWCARD FRAME SYSTEMS

SHOWCARD HOLDERS



SHOWCARD HOLDER DK WITH SPRING CLAMP

DK wire holder (pair) made of grey plastics with spring clamp, suits wires with Ø 4 - 8 mm, with a vertical wire distance of min. 18 mm, aluminium tube adjustable 250 - 500 mm with T-piece and frame A4 in OEK standard colors.

35434-xx/-500

The DK showcard holder can be used wherever it is not possible to install bases – especially designed for being attached to wire baskets, shopping trolleys, sales tables and others.

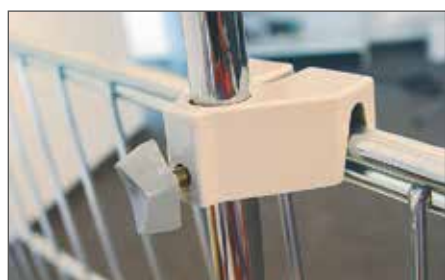

SHOWCARD HOLDER DK

DK wire holder (pair) made of grey plastic, suits wires with Ø 4 - 8 mm, with a vertical wire distance of min. 18 mm, chromium tube adjustable 320 - 620 mm, frame A4 and T-piece in OEK standard colors.

35424-xx



SHOWCARD HOLDER RS

Slim plastic base, frame and T-piece in OEK standard colors.

A5 | 33905-xx
A4 | 33904-xx

There will always be a place for this slim and flat RS base. If placed underneath the products, this model offers a stable and space saving solution of presentation.



SHOWCARD HOLDER RS DIRECT

Slim plastic base with direct frame adaptor and frame in grey. Other colors available upon request.

A5 | 33805-03
A4 | 33804-03





This model has been designed for use at sales stands with an integrated internal thread.

Also available with adjustable chromium tube and thread M10 upon request.

SHOWCARD HOLDER GW

Fixed chromium tube 310 mm with threaded bolt M8, frame and T-piece in OEK standard colors.

A4 | 35914-xx



CLAMPHOLDER "MAXI VISION" WITH CLAMP

Set consisting of clampholder 100 and big, massive clamp with rubber inlay, clamp range up to max. 30 mm. Connectors in white.

without rod | 28421-00
with rod 100 mm | 28421-00/100

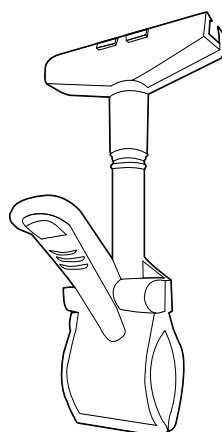

UNIVERSAL CLAMP 25

Very stable clamp for attachment of frames onto textile stands (with oval tubes), baskets, shelves, etc. with up to max. 25 mm thickness. An inside rubber inlay prevents any scratching and secures a tight fit even on slippery surfaces. Supplied with T-piece 70 mm (series 100). Made of PC, clear.

20571-00

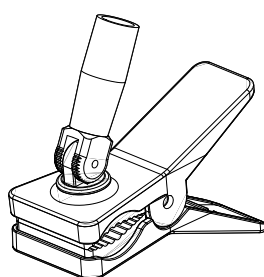

DISPLAY CLAMP TO TAKE TUBES Ø 12 MM

Revolving clamp 360° to take tubes Ø 12 mm. Clamps material between approx. 8-34 mm, plastic with an inside rubber inlay. Colors: white, grey, red

Please order MF-connector or tube as well as T-piece and frame separately.

20580-xx



SHOWCARD FRAME SYSTEMS

SHOWCARD HOLDERS

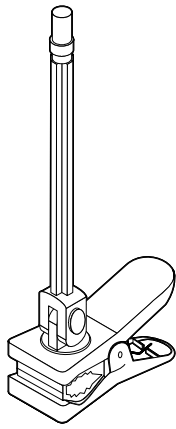

CLAMP ALLROUNDER

Revolving clamp with rod 155 mm, suitable for T-piece Ø 10 mm, clamp range for materials with 8 - 34 mm thickness, with rubber inlay to prevent any scratching. Colors: white, red. Other colors upon request (e.g. black or grey). (Showcard frame and T-piece to be ordered separately.)

20560-xx



CARDBOARD CLAMP 140

To attach frames to boxes, fruit baskets or similar with up to 22 mm thickness. Set consisting of clamp 140 black with hinge, MF connector 50 mm black or fixed chromium tube 160 mm and T-piece in OEK standard color. Frame to be ordered separately.

with chromium tube | 35500-xx/160
with MF connector | 35550-xx

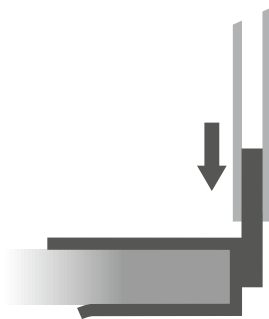

SHOWCARD STAND FOR EURO PALLET "WEATHER-RESISTANT"

Pallet claw to attach onto Euro pallets, made of zinc metal and connected wind-resistently with aluminium tube adjustable up to 800 mm, with T-piece in OEK standard colors (showcard frame to be ordered separately). Showcard stand version for Chep-pallets available upon request.

33770-xx/-800

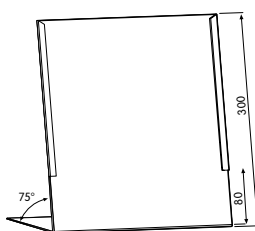

L-DISPLAY FOR LAMINATED POSTERS

To insert laminated posters A4 landscape. Especially designed for outdoor use: wind resistant if L base is placed underneath the goods, zinc coated metal plate, height: 300 mm.

18644-00





SHELF EQUIPMENT

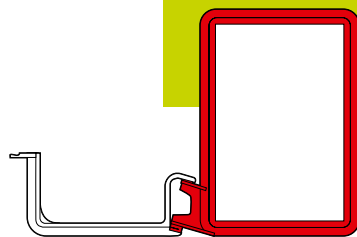

SHELF EQUIPMENT

KLICK SHELF BARKERS

KLICK SHELF BARKER

Made of premium, unbreakable plastic with rear Klick adaptor. The fastening elements (see Klick accessories) are inserted into the dovetail guide on the rear of the barker and locked securely into place with an audible "Klick".

Available in OEK standard colors, clear and silver. Gold and chromium are available upon request.

A9	13090-xx	148 x 70 mm	13004-xx
A8	13080-xx	210 x 59 mm	13003-xx
A7	13070-xx	210 x 74 mm	13002-xx
A6	13060-xx	210 x 99 mm	13001-xx

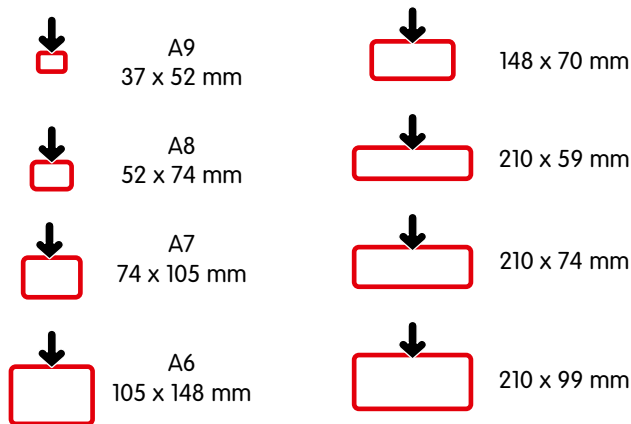

The wide range of **Oechsle Klick accessories** offers various fastening possibilities. You will find an overview on the following catalogue pages.



KLICK ACRYLIC BARKER

The alternative to bring your message "crystal clear" to customers' attention. The print is completely covered and protected, without distracting lines or colors, clear. With "dovetail" adaptor on the rear to suit Klick accessories.

A8	13580-25
A7	13570-25
A6 portrait	13561-25
A6 landscape	13560-25
148 x 70 mm	13504-25

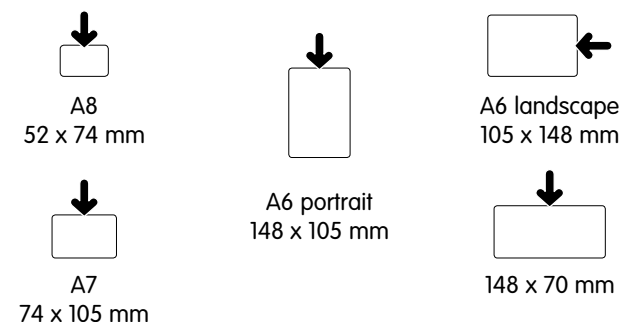

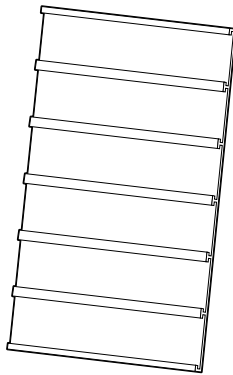

KLICK LABEL HOLDER EXTRA

For insert of 6 labels, size 110 x 26 mm, max. thickness 0,9 mm, with Klick adaptor on the rear. External size: 110 x 175 mm. Colors: white, grey, anthracite.

EXTRA without support | 13300-xx
EXTRA with support (grey) | 36500-03



EXTRA PVC COVER (SET)

To cover labels, made of PVC with 0,4 mm thickness, non-reflective, clear. Size: 110 x 26 x 0,4 mm. PU: 60 pcs. per set.

24142-00



CHALK BOARDS

Made of polystyrene, both sides slate coated, for showcard frames of same size, thickness 0,95 mm, rounded edges, black. Other sizes available upon request.

Attention: These chalk boards are not heat-resistant. It is not excluded that they get deformed e.g. by direct solar irradiation. For heat-resistant chalk boards please see page 194.

A8 | 30012-A8/095
A7 | 30012-A7/095
A6 | 30012-A6/095

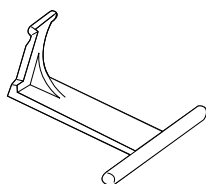

SUPPORT

Frame support and distance holder, colors: clear, white.

23750-xx



SHELF EQUIPMENT

KLICK ACCESSORIES (SERIES 300)



HOOK CLIP Ø 10 MM
For wire baskets, containers, etc., fits wires up to Ø 10 mm. For baskets with a sloping wire front we recommend to use support (23750-xx) as distance holder, white.

23300-26

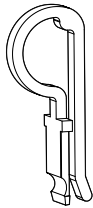

SUSPENSION HOOK FRUITS & VEGETABLES
To suspend price cassettes and Klick shelf barkers from horizontal tubes and relings with Ø 12 mm, used mainly in fruit- and vegetable applications, white.

23015-26

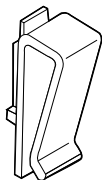

FASTENER FOR VERTICAL GLASS PANELS
Fits panels with up to 6 mm thickness, white.

23320-26



FASTENER FOR VERTICAL METAL PLATES
Fits thin metal shelving with upright front edge or similar, white.

23330-26

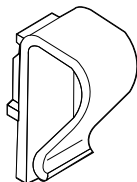

HOOK CLIP Ø 20 MM
For wire baskets, fine tubes etc. with Ø up to 20 mm, white.

23310-26

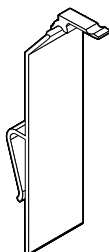

CARDBOARD CLAMP 10
To attach Klick shelf barkers, price cassettes, etc. to cartons or boxes with up to 10 mm thickness, clear.

23710-00



KLICK CARDBOARD CLAMP 20
To attach Klick shelf barkers, price cassettes, etc. to containers, trays and baskets with up to 20 mm thickness, clear.

23715-00



SHELF EQUIPMENT

KLICK ACCESSORIES (SERIES 300)

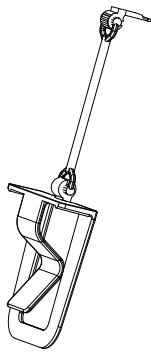

NEW

CARDBOARD CLAMP 70 WITH FK ROD
To attach to baskets, boxes or similar with up to 18 mm thickness. Set consisting of cardboard clamp 70 and FK rod with Klick adaptor, to be used with price cassettes, Klick frames, acrylic frames, electronic shelf labels and others. Color: black. Other colors are available upon request.

with rod 50 mm | 35492-10/050
with rod 100 mm | 35492-10/100
with rod 200 mm | 35492-10/200

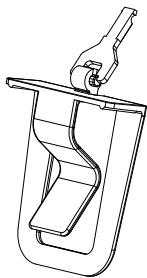

NEW

CARDBOARD CLAMP 70 WITH FK CONNECTOR 25
To attach to baskets, boxes or similar with up to 18 mm thickness. Set consisting of cardboard clamp 70 and FK connector 25. Color: black. Other colors are available upon request.

35490-10

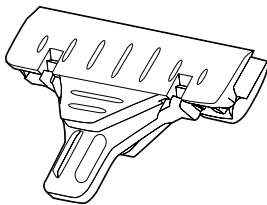

CLAMPHOLDER

Clampholder with Klick adaptor and clamp 100 mm wide to take signs, cartons, etc. with up to 5 mm thickness, clear. To be used with the Klick accessories range.

17060-00

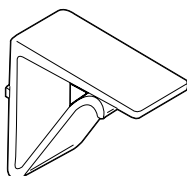

FASTENER FOR LEDGES

For ledges, boards and shelves with up to 10 mm thickness, white.

23160-xx

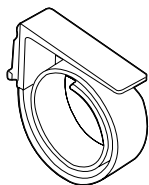

COIL-SPRING FASTENER

For tables, shelves etc., with up to 60 mm thickness, 1-part, white.

23100-26

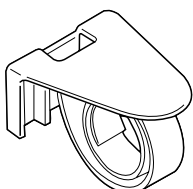

FASTENER WITH COIL-SPRING

Massive and stable fastener for tables, shelves etc., with up to 60 mm thickness, 2-parts, coil-spring white, upper part clear.

23110-26



SHELF EQUIPMENT

KLICK ACCESSORIES (SERIES 300)

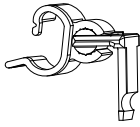

NEW

KLICK ADAPTOR WIRE TECH 100
Swiveling holder with Klick adaptor 2-parts mounted. To be used on wire shelves Wire Tech and Wire Tech 100 (Wanzl). Inclination angle quintuplicately adjustable. Colors: grey/clear, black/clear and black/black.

23090-xx

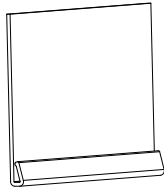

NEW

L-RAIL
L-rail with adhesive, suitable to Klick rail adaptor small & large. Colors: white, green.

shelf length 1000 mm | 23690-xx

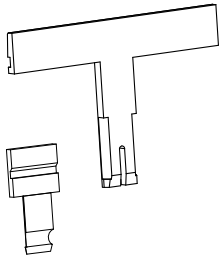

NEW

KLICK RAIL ADAPTOR
Adaptor to insert into L-rail, suitable to all elements of Klick range (series 300). Color: clear.

small | 23693-00
large (available upon request) | 23695-00

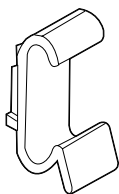

CLIP FASTENER FOR TEGOMETALL SHELVES
For an inclined presentation, white.

23610-26

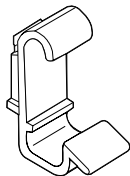

CLIP FASTENER FOR LINDE SHELVES
For a 90° presentation, white.

23620-26

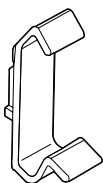

CLIP FASTENER FOR TICKET RAIL 40 MM
Clips outside, white.

23640-26

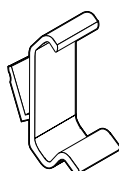

CLIP FASTENER FOR TICKET RAIL 40 MM/15°
Clips outside with a 15° presentation angle, white.

23650-26



SHELF EQUIPMENT

KLICK ACCESSORIES (SERIES 300)

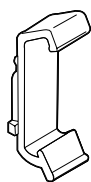

CLIP FASTENER FOR TICKET RAIL 26 MM
Clips outside, white.

23630-26



CLIP FASTENER FOR TICKET RAIL 50 MM
Clip for attaching click frames, price
cassettes, etc. on ticket rails 50 mm,
clips outside, white.

23661-26

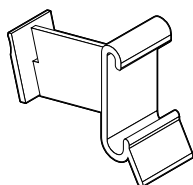
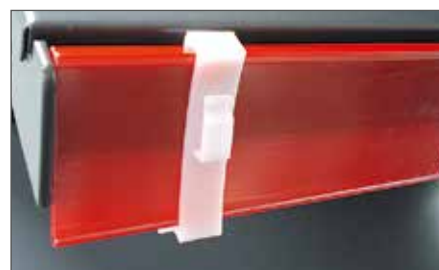

PENDULUM CLIP FASTENER FOR
TEGOMETALL SHELVES
Clip with longer arm, made of flexible
plastics, white.

23600-26

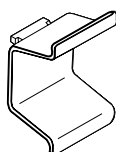

CLIP FASTENER FOR TICKET RAIL
Up to 30 mm, clips inside, white.

23540-26

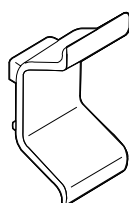

CLIP FASTENER FOR TICKET RAIL
Up to 40 mm, clips inside, white.

23560-26

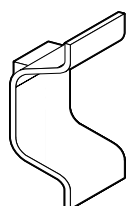

CLIP FASTENER FOR TICKET RAIL
Up to 50 mm, clips inside, white.

23570-26

SHELF EQUIPMENT

KLICK ACCESSORIES (SERIES 300)

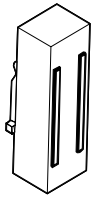

MAGNETIC FASTENER VERTICAL
Magnetic fastener for a quick attachment of shelf barkers to metal shelves or any other metallic equipment. Magnetic force up to approx. 2,8 kgs. Colors: clear, white, grey.

23220-xx

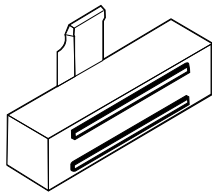

MAGNETIC FASTENER HORIZONTAL
Magnetic fastener for a quick attachment of Klick barkers to metal shelves or any other metallic equipment. Magnetic force up to approx. 2,8 kgs, clear.

23225-00

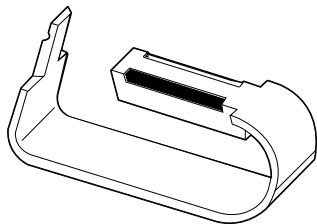

MAGNETIC SWING FASTENER
The Klick barker is attached to the shelf etc. from below, magnetic force up to approx. 2,8 kgs. Can be pressed downwards to make the EAN label readable, white.

23125-26

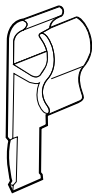

CLAW FASTENER
For wire baskets, wire-lattice etc., fits wires up to Ø 5 mm, white.

23410-26

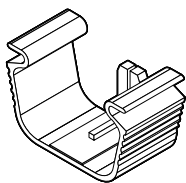

CLIP FOR WIRE BASKETS
Suits wire baskets, shelves, etc., for wires with distance of up to 40 mm and wire-Ø 2 - 5 mm, white.

26040-26

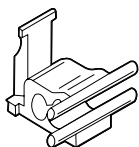
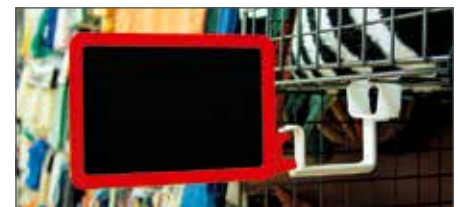

SLOPING FASTENER
For horizontal wire shelving and shelf baskets with sloping front, fits wires up to Ø 5 mm, white.

23400-26

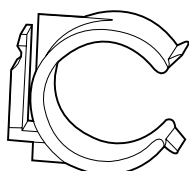

TUBE CLIP
For sales stands, cloths racks, tables etc., fits tubes with Ø 23 - 28 mm, white.

23500-26



SHELF EQUIPMENT

KLICK ACCESSORIES (SERIES 300)

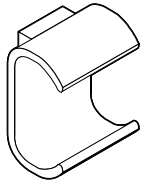

OVAL TUBE CLIP
Fits oval tubes 15 x 30 mm, clear.

23510-00

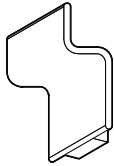

SLATWALL-CLIP
For slatwalls, white.

23780-26



FASTENER FOR PEG BOARD HOOKS
With locking function to secure a certain viewing angle, 2-parts, color: transparent.

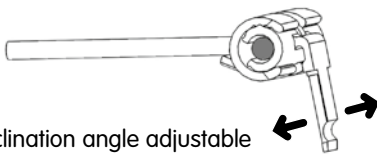

Inclination angle adjustable

VERSION "A"
For hooks with **front wire** (e.g. Geck, ZOK and partly TEGO).

28718-00A

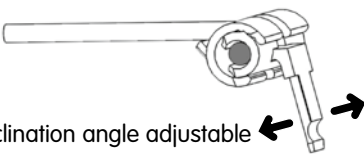

Inclination angle adjustable

VERSION "B"
For hooks with **bottom wire** (e.g. Hohage, Wanzl and TEGO).

28718-00B

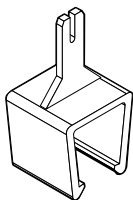

FASTENER FOR MINIKOMET SALES STAND
For fastening Klick barkers, etc. onto horizontal square tubes 21,2 x 21,2 mm, clear.

23460-00

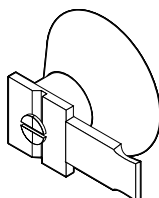

SUCTION CUP
For a quick attachment of Klick barkers, etc. to smooth surfaces, such as glass etc., clear.

23700-00

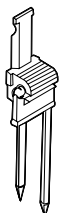

PIN HOLDER SWIVEL-TYPE
To fix price and product information directly on the product, e.g. in wool, white.

23830-26



SHELF EQUIPMENT

KLICK ACCESSORIES (SERIES 300)



METAL STICKPIN
With stainless steel needle.

23820-00

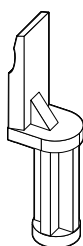

KLICK TUBE ADAPTOR
To connect Klick barkers, etc. to chromium tubes, Ø 10 mm, grey. For suitable tubes please see chapter "Components".

23810-03

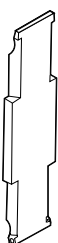

CONNECTOR
To connect several Klick barkers, price cassettes, etc., clear.

23010-00

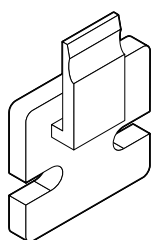

WALL FASTENER
For an invisible wall fastening of Klick barkers, available for screw fixing or with double adhesive tape, clear.

screw mounting | 23130-00
with double | 23131-00
adhesive tape

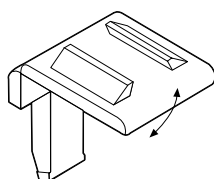

HINGED ADAPTOR
With film hinge, swivel-type, clear.

23140-26

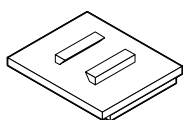

ADHESIVE PLATE (29 X 35 MM)
With double adhesive foam tape. Sticks onto cards, chalk boards etc., suits Klick accessories, white.

23150-01





SWIVEL HINGE

To fix Klick barkers in an inclined angle in connection with the FK connector and different elements such as fastener for ledges, fastener with coil-spring, transparent.

23815-00



ADAPTOR FOR OEK CLICK ACCESSORIES WITH CASSETTES OF OTHER PRODUCERS

For fixing cassettes or frames of other producers with OEK Klick accessories (series 300), black.

23013-10



ADAPTOR FOR OEK CLICK FRAMES ONTO ACCESSORIES OF OTHER PRODUCERS

For fixing OEK Klick frames, qP price cassettes, etc. onto accessories of other producers, white.

23012-01



CLICK BOTTLE HOLDER

Fits onto all PET bottles (1,5 L - 1,0 L - 0,5 L), with rear Klick adaptor to hold qP price cassettes, shelf barkers, etc., colors: clear, grey.

20026-xx



VISIONLINE CLICK ADAPTOR WITH CLAMP "VISION 58"

Using the Klick adaptor, all price cassettes and Klick shelf barkers can be combined with the range of Visionline elements. Set consisting of Visionline Klick adaptor (white) and clamp Vision 58 (clear).

28437-00



SHELF EQUIPMENT

SHOPPER STOPPERS

SHOPPER STOPPERS & BANNER HANGERS

Considered as real attention-grabbers our swivel frames, shopper stoppers and banner hangers are ideal for the price marking directly at the shelf. They will guide your customers straight to new products and special sales promotions.

We offer a wide range of product variants and fixing possibilities which are suitable for all common types of shelving.

Remark:

In need of any other colors?

If you order at least 1.000 pieces, we should be happy to produce the swivel-type frames in any of our OEK standard colors. In this case, however, we reserve the right to make an overdelivery or underdelivery of +/- 10%.

SHOPPER STOPPER WITH SWIVEL-CARDHOLDER

With square magnet, magnetic force up to 5,6 kgs, swivel-arm in standard short or long version white, clear swivel-cardholder 35 mm to take signs, etc. with up to 0,5 mm thickness.

short (L = 65 mm)		33909-00/01
long (L = 85 mm)		33911-00/01

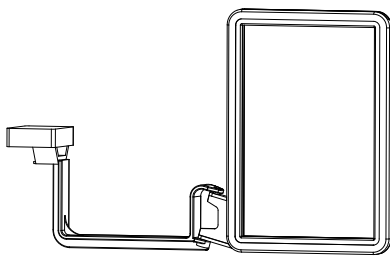

SHOPPER STOPPER WITH SWIVEL FRAME

For fixing onto metal shelving, magnetic force up to 5,6 kgs, due to gravity the frame swivels back 90° to the shelf, swivel arm (L = 65 mm) and magnet in white. Frame colors: white, red, grey upon request.

A6 landscape		33956-xx
A6 portrait		33966-xx
A5 portrait		33913-xx
A5 landscape		33914-xx



SHOPPER STOPPER WITH LONG ARM (85 MM) AND SWIVEL FRAME

With a longer arm especially suitable for metal shelving with integrated lighting, swivel arm and magnet in white. Frame colors: white, red, grey upon request.

A6 landscape		33957-xx
A6 portrait		33967-xx



SHOPPER STOPPER WITH SHORT ARM (65 MM) WITH SWIVEL FRAME AND CLIP FOR WIRE BASKETS

To fix to metal wire shelving, suitable for wire distances up to 40 mm with a wire Ø of 2 - 5 mm, swivel arm and wire clip in white. Frame colors: white, red, grey upon request.

A6 landscape		33976-xx
A6 portrait		33986-xx



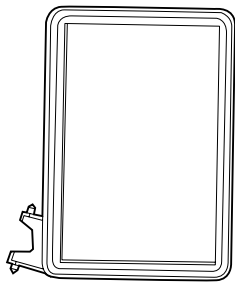

SWIVEL FRAME

Frame always swivels back in 90° position to the shelf by gravity, to be mounted with swivel arm and different fixing accessories (as described below in detail). Colors: white, red, grey upon request.

A6 portrait		16666-xx
A6 landscape		16656-xx
A5 portrait (series 100)		16502-xx
A5 landscape		16501-xx



SWIVEL ARM

Connecting element between swivel frame and fixing accessories, white. Longer version especially suitable for shelves with integrated lighting.

short (L = 65 mm)		26070-01
long (L = 85 mm)		26071-01

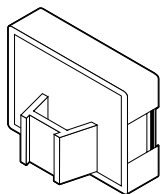

RS MAGNET (32 X 38 MM)

Magnetic holder to take swivel arm, magnetic force up to 5,6 kgs, white.

26230-01

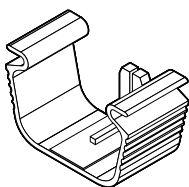

RS CLIP FOR WIRE BASKET

Suitable for wires with a distance of up to 40 mm, wire Ø of 2 - 5 mm, white. Also to be used as Klick accessory part.

26040-26

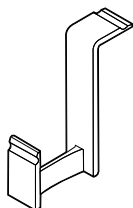

KLICK RS ARM

To fix Klick frames e.g. to shelves with adhesive plate, RS-magnet, wire clip etc., white.

26060-01



SHELF EQUIPMENT

SHOPPER STOPPERS

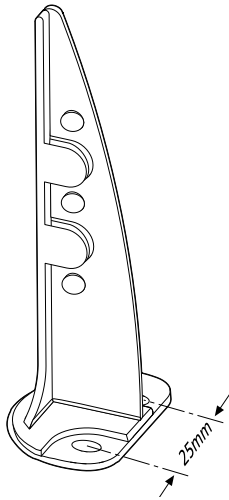

SHOPPER STOPPER FOR SHELVING
Suitable for Yudigar and Kider shelves with rectangular (5 x 10 mm) and rhomboid shaped (5 x 5 mm) holes, incl. 2 fixing clips, to clamp special poster pocket 3-hole, clear.

with square holes | 17411-00

Suitable for CEFLA shelves with holes \varnothing 7 mm, incl. 2 fixing clips, to clamp special poster pocket 3-hole, clear.

with round holes | 17410-00



FIXING CLIPS

For fixing of above shopper stoppers, clear.
PU: 1 bag containing 100 pcs.

round		49098-26-M/6,8
square		49098-26-M/5x5

SHOPPER STOPPER WITH ROUND MAGNET

For use on metal shelving with magnet \varnothing 50 mm, magnetic force up to approx. 18 kgs., clear. To clamp 3-hole poster pocket. Available upon request.

17420-00



SHOPPER STOPPER WITH SUCTION CUP

For use on glass or metal shelving, suction cup \varnothing 36 mm, clear. To clamp 3-hole poster pocket.

17430-00

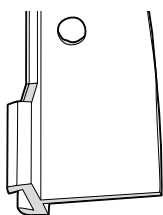

SHOPPER STOPPER KLICK

With Klick adaptor, to suit all fastening elements of Klick series 300 accessories, clear.

17441-00



SHELF EQUIPMENT
SHOPPER STOPPERS

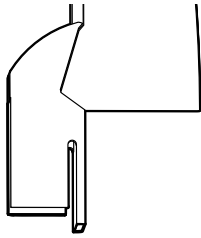

SHOPPER STOPPER PRIMA
Suitable to mount onto shelf dividers standard type 1 and 2 with height 60 and 120 mm, clear.

17440-00

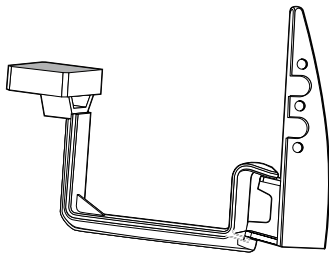

SHOPPER STOPPER SWIVEL-ARM WITH MAGNET, 3-PART
For use on metal shelving, to clamp special poster pocket 3-hole. Set consisting of white square magnet, magnetic force up to 5,6 kgs, with long swivel-arm white (L=85 mm) and shopper stopper clear.

28005-00/01



POSTER POCKET 20 X 20 CM WITH 3-HOLE
To be used with shopper stoppers described above, with 3 clamp holes for a secure and tight fit, made of non-reflecting PVC, clear.

29600-0007/04

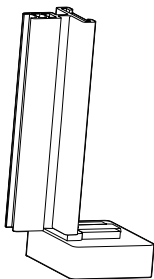

SHOPPER STOPPER SUPERGRIP WITH MAGNET, 3-PART
Square magnetic fastener white, magnetic force up to 5,6 kgs, with Klick adaptor and supergrip holder 75 mm, to insert and hold signs, crowners, cards etc. with up to 2 mm thickness. Strong hold guaranteed!

17421-00

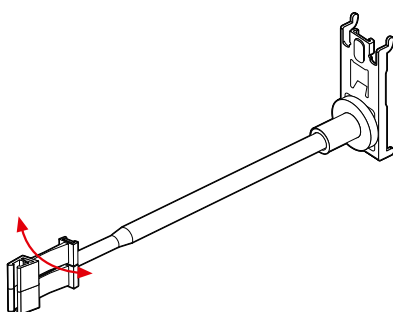

SHOPPER STOPPER FOR PEG BOARD
To attach to peg boards with hole centres at 30 mm (corresponds to European standard), fixed chromium tube 310 mm and elastic frame clips. The frame (series 100) is held safely and swings back into its original position (please order separately).

17450-03/0310



SHELF EQUIPMENT

BANNER HANGERS



BANNER HANGER, HORIZONTALLY ADJUSTABLE

Horizontally adjustable banner hanger, with round magnet (zinc-coated) Ø 50 mm, alu tube with end cap grey, length 730 mm, incl. 2 tube hooks Ø 16 mm, clear. Special feature: black screw (M6 x 20) to level out differences in height of max. 10 mm. Maximum banner weight: 7 kgs.

26673-00/0730



BANNER HANGER WITH MAGNET

Magnetic base white 60 x 35 mm with hinge, alu tube Ø 10 mm, length 250 resp. 400 mm, end cap white. Suspensions accessories to be ordered separately.

banner hanger 250 | 26570-01/0250
 banner hanger 400 | 26570-01/0400



BENT BANNER HANGER WITH MAGNETIC BASE

Magnetic base white 60 x 35 mm with hinge, bent alu tube Ø 10 mm (height 70 mm), length 250 mm, white end cap. Suspensions accessories to be ordered separately.

26572-01/0250



BANNER HANGER FOR TEGO UPRIGHTS

Zinc-coated metal hook for Tego uprights, with alu tube Ø 10 mm, adjustable 400 - 750 mm, tube fixing grey, white end cap. Suspensions accessories to be ordered separately.

26580-00/-0750



BANNER HANGER FOR SHELF UPRIGHTS

Adjustable clamp made of zinc-coated metal, suitable for different shelf uprights with rectangular slots, alu tube adjustable 400-750 mm, tube fixing grey, white end cap. Suspension accessories to be ordered separately.

26585-00/-0750



SHELF EQUIPMENT

BANNER HANGERS



TUBE HOOK TIGHT
For a secure and tight suspension of poster pockets, banners, punched category signs, etc. for tubes Ø 10 mm. Colors: grey, clear.

21340-xx/D10



TUBE HOOK (RING)
For a secure suspension of promotion banners, punched category signs, poster pockets, etc., with ring Ø 10 mm, clear.

21355-00/D10



PETG-FLAGPOLE
Bent holder made of PETG, 1,0 mm. Size (W x H x D): approx. 880 x 31 x 12 mm, to suspend flags, banners etc. from banner hangers and tubes with Ø 10 mm, oscillation by gravity. Suitable for banner hangers on prior page, incl. screw and rubber ring (black) as sliding prevention.

21345-00

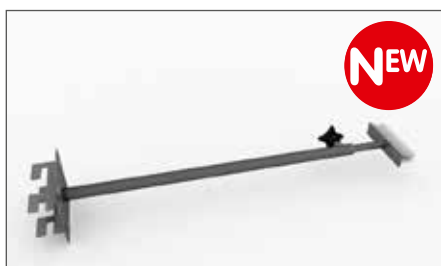

UNIVERSAL SIGN HOLDER
To be fixed to Tego-holms or for universal fixing with screws. Material: polished zinc-coated steel. Length: approx. 350 mm, adjustable up to 600 mm. Front with welded-on plate and flexible display holder (75 mm), for signs of maximal 2 mm thickness. Available upon request.

26686-91/-600



BENDED BANNER HANGER R100
Bent, massive alu profile 300 x 300 mm with 2 white magnetic fasteners, magnetic force up to 5,6 kgs and 2 clear suspension hooks. Profile suits frame accessories (series 100).

26675-01/0300

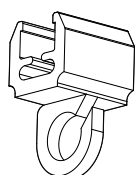

SUSPENSION HOOK FOR BANNER HANGER R100
Hook 90° (for Ø 9 mm) to suspend punched posters, banners, etc., clear.

21333-00



SHELF EQUIPMENT

SHOPPER STOPPER FOR SCANNER RAILS

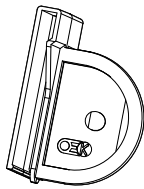

SHOPPER STOPPER HR

To insert into scanner rails, for punched crowners, cards or signs with up to 1 mm thickness, clear. Punching at 10 mm.

height 39 mm | 17403-00
height 53 mm | 17404-00

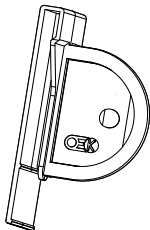

SHOPPER STOPPER ME

Punching at 12 mm.

height 39 mm | 17405-00
height 53 mm | 17406-00

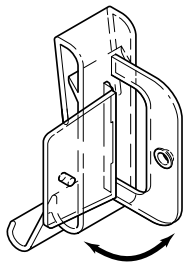

SHOPPER STOPPER D

Fitting onto various scanner rails 30 and 39 mm high to hold punched stoppers, crowners and cards with up to 1 mm thickness. Punching at 12 mm. With hinge for easy change of stoppers, clear. PU: 100 pcs.

17401-00



SPRING CLIP

To be fixed onto scanner rails 39 mm, to take signs, cards etc. with max. 0,2 - 0,6 mm thickness, polished stainless steel.

28050-00

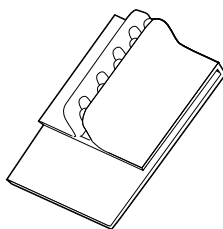

SHOPPER STOPPER SC

To insert in scanner rail with 39 mm height, for cards with max. 0,3 - 0,6 mm thickness, 90° position to the shelf, clear.

17400-00

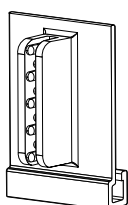

SHOPPER STOPPER B

To clip onto the bottom edge of scanner rails, tight fitting for a guaranteed secure position, to take cards with max. 0,3 - 0,6 mm thickness, clear.

17402-00



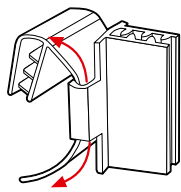

FLEXIBLE SHOPPER STOPPER
SUPERGRIP

For fixing onto scanner rails, sign holder adjustable in 90° angle, to take signs, crowners etc. with up to 2 mm thickness, clear. PU: 100 pcs.

28011-00

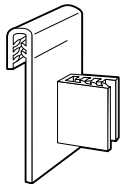

SHOPPER STOPPER SUPERGRIP

For fixing onto scanner rails, to take signs, crowners, etc. with up to 2 mm thickness, clear. PU: 100 pcs.

28010-00/20

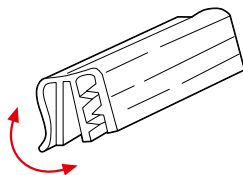

PARALLEL SHOPPER STOPPER
SUPERGRIP

For parallel fixing onto scanner rails, to take signs, crowners, etc. with up to 2 mm thickness, length 25 mm with hinge, clear. PU: 100 pcs.

28012-00/25

SWIVEL-CARDHOLDER 35
WITH MINI MAGNET

Swivel-cardholder 35 mm clear to take crowners, signs, etc. with max. 0,5 mm thickness, set with 2 mini magnets.

28438-00



SWIVEL-CARDHOLDER 35
WITH SUCTION CUP

Swivel-cardholder 35 mm clear to take crowners, signs etc. with max. 0,5 mm thickness, set with suction cup Ø 45 mm.

28439-00

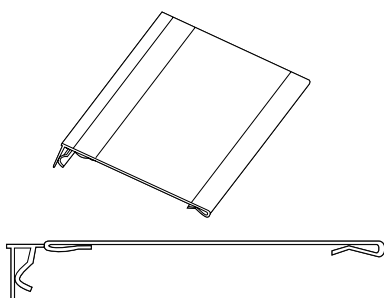

PARALLEL SHOPPER STOPPER WITH HINGE
To fix into scanner rails, color: clear.

- | | | |
|----------------|--|---------------|
| A7 (landscape) | | 49500-00/0105 |
| 148 x 110 mm | | 49501-00/0148 |
| (landscape) | | |
| 298 x 110 mm | | 49501-00/0298 |
| (landscape) | | |
| A6 (portrait) | | 49502-00/0105 |



SHELF EQUIPMENT

SHOPPER STOPPER / SHOPPER WOBBLER

WE OFFER A VARIETY OF POSSIBILITIES FOR PRESENTING YOUR ADVERTISING MESSAGE – IN THE SHELF OR CHECKOUT AREA.

- shopper wobbler - starts moving with the slightest air flow
- shopper stopper - protruding from the shelf
- easy to hook in the scanner rails
- guides the customers' eyes straight to the product

- Material:
- unplasticized PVC, white or transparent
 - thickness: 0,3 mm - 0,5 mm
 - printed, shaped and folded

- Print:
- UV offset printing: bright, brilliant, scratch-proof gloss finish
 - Screen printing: well covering, durable and UV-resistant
 - Digital printing: ideal for customized prints ordered in smaller quantities

We also supply shopper wobblers or shopper stoppers for your individual applications providing you maximum freedom of choice with regard to material, size, shape, color and effects. Just contact us. We will be happy to advise you personally!

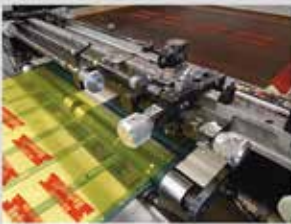

PRINTING



PUNCHING



EDGE BENDING





Shopper wobbler round, square or in special shapes



Shopper stopper standard, punched out with viewing window or with transparent viewing windows



Shopper stopper for ESL price displays



Special shopper stopper: with clips made by Oechsle



THE UNBEATABLE DUO

SHELF EQUIPMENT

DELICATESSEN & COUNTER MARKING



PRICE CASSETTES – OFFERING VARIOUS OPTIONS TO MARK YOUR FRESH FOOD

PRICE CASSETTES

For the price marking of delicatessen, fine food as well as fruits and vegetables our price cassettes offer a wide range of possibilities. Already equipped with ready-to-use folded number strips the closed cassettes allow for a clean, quick and informative marking of your fresh food and gourmet products.

For fixing the cassettes you can use all elements of the Klick accessories (series 300) which are specified in the chapter shelf promotion.

Remark:

We also supply customized folded number strips, labels etc. designed and manufactured according to your specific requirements for contents, word art, language etc.

Just send us your inquiry.

Prints and customized versions are our special strengths.



PRICE CASSETTE DELICATESSEN A8

Price cassette with 2 different rear adaptors: one suitable for OEK Klick accessories (series 300) and the other for accessories of other producers. With 6-digit number strips (3 large, 2 small numbers, with unit/weight information, bilingual German/English, no wording), white PVC printed black, 2-parts mounted, cover clear, colors of body: white, red and black. PU: 25 pcs.

with number strips	13205-xx
for wording	13208-xx
(without inlays)	



PRICE CASSETTE QP 7760

Price cassette with rear Klick adaptor, with 6-digit number strips (3 large, 2 small numbers with unit/weight information, bilingual German/English, no wording). White PVC printed black, assembled, colors of body: white, rape yellow, traffic red, black. PU: 25 pcs. Available upon request.

13249-xx

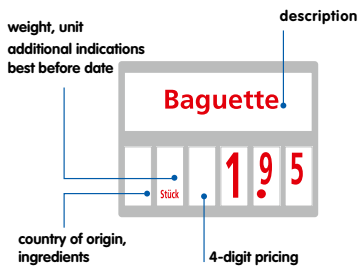

PRICE CASSETTE QP 7760
"SPECIAL EDITION"

For specific price marking of bread/bakery, meat/sausage, cheese, sea food, etc. (containing specific additional product information about ingredients, origin, etc). Available upon request.

1324x-xx



VISIONLINE KLICK ADAPTOR WITH
CLAMP "VISION 58"

Using the Klick adaptor, all price cassettes and Klick shelf barkers can be combined with the range of Visionline elements. Set consisting of Visionline Klick adaptor (white) and clamp Vision 58 (clear).

28437-00



SHELF EQUIPMENT

DELICATESSEN & COUNTER MARKING

PRICE TAGS

Use the open, medium-sized price cassettes and displays with folded number strips and spiral blocks for convenient and flexible price labeling in the counter area.

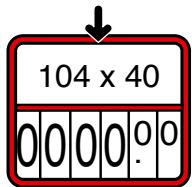

110 x 85

Printed goods labels are available upon request.

PRICE BARKER TPS 110 X 85 MM

Made of high-grade plastic, for 6-digit number strips, with rear Klick adaptor. Colors: white, red, green, black. Outside dimensions 110 x 85 mm, size for wording 104 x 40 mm, without number strips, wording and clear PVC protective cover. Available upon request.

13191-xx

PVC PROTECTIVE COVER

PVC cutting 104 x 40 mm, clear. Available upon request.

PVC protective cover | 24145-00



FOLDED NUMBER STRIPS FOR TPS 110 X 85 MM

Made of white PVC printed black with 2 small and 4 large digits or large digits only, sheet with 3 number strips 214 x 14,5 mm each. Available upon request.

24105-00

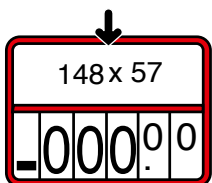

155 x 110

Printed goods labels are available upon request.

PRICE BARKER TPS 155 X 110 MM

Made of high-grade plastic, for 6-digit number strips, with rear Klick adaptor. Colors: red, green. Outside dimensions 155 x 110 mm, size for wording 148 x 57 mm, without number strips and wording. Available upon request.

13192-xx

FOLDED NUMBER STRIPS FOR TPS 155 X 110 MM

Made of white PVC printed black with 2 small and 3 large digits or large digits only and additional information such as weight, piece etc., sheet 269 x 129 mm with 6 number strips 269 x 21,5 mm each. Available upon request.

small and large digits | 24126-00

large digits only | 24126-01



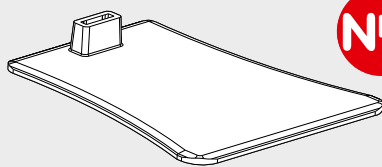

NEW

FK-FIX BASE

Plastic base to take FK-Fix rods. Rods can also be used 180° swiveled. Colors: clear, white, black (other colors are available upon request).

23970-xx

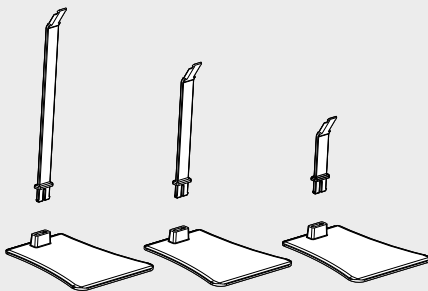

FK-FIX ROD

To be combined with FK-Fix base, inclined 30° from height of Klick adaptor. Colors: clear, white, black (other colors are available upon request).

- 50 mm | 23975-xx
- 100 mm | 23977-xx
- 150 mm | 23979-xx

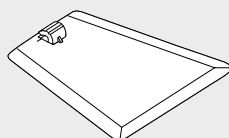

FK BASE

Plastic base with adaptor to take FK rods 50, 100 and 200 mm. Colors: clear, white, black.

23900-xx

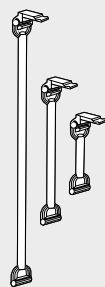

FK ROD

With Klick adaptor, to be combined with FK base, tray clip or universal clip. Colors: clear, white, black.

- 50 mm | 23905-xx
- 100 mm | 23910-xx
- 200 mm | 23920-xx



FK CONNECTOR

To connect e.g. universal or tray clip with price barkers or price cassettes. Colors: clear, white, black.

23940-xx

SHELF EQUIPMENT

DELICATESSEN & COUNTER MARKING

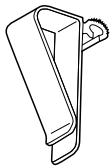

FK UNIVERSAL CLIP

For an universal attachment of Klick frames, etc. with rear Klick adaptor, to be combined with FK rods or FK connector. Colors: white, clear, black.

23960-xx

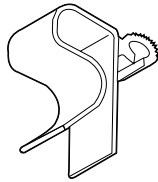

FK TRAY CLIP

To attach Klick frames etc. to trays and bowls, to be combined with FK rods or FK connector. Colors: white, clear, black.

23950-xx



MINI-CARDHOLDER

To hold small signs and labels made of paper, carton, etc. with a thickness of 0,3 - 1,3 mm and a max. size of 100 x 80 mm, width 25 mm. Colors: white, black. To be used with Klick accessories or standing alone as support.

17010-xx

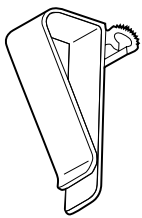

MINI-CARDHOLDER WITH UNIVERSAL CLIP

Delicatessen clip for general use, consisting of Mini-cardholder and universal clip. Colors: white, black. Not assembled.

36010-xx

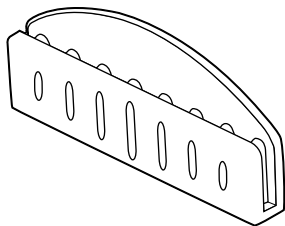

CARDHOLDER

To hold signs made of paper, carton, etc. with a thickness of 0,3 - 1,0 mm, width 60 mm. Colors: clear, white, grey, black. To be used with Klick accessories.

17000-xx

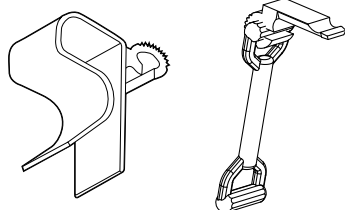

CARDHOLDER WITH TRAY CLIP

Clip to fit delicatessen trays, bowls, etc., consisting of cardholder, FK rod and tray clip. Colors: clear, white, black. Not assembled.

36000-xx



CARDHOLDER WITH FK ROD

Set consisting of cardholder 60 mm with FK rod and FK base. Colors: clear, white, black.

with FK rod 50 | 36030-xx
with FK rod 100 | 36031-xx
with FK rod 200 | 36032-xx



CLAMPHOLDER WITH FK ROD

Set consisting of clampholder Klick 100 mm, FK rod and FK base. Can take signs and cartons up to 5 mm thickness.
Color: clear.

with FK rod 50		36035-00
with FK rod 100		36036-00
with FK rod 200		36037-00

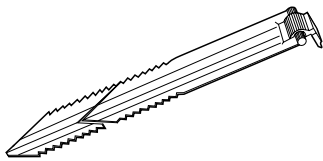
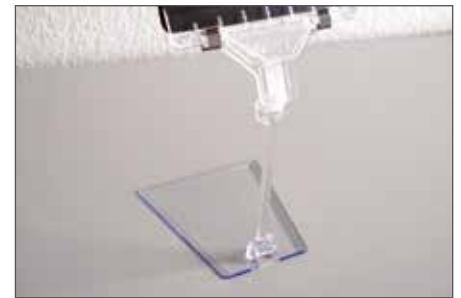

ICE STICK "KLICK"

To be used in fish counters with crushed ice, length 150 mm, breakable to 110 mm, clear.

23065-00



ICE-STICK "KLICK" WITH MINI-CARDHOLDER

To be used in fish counters with crushed ice, length 150 mm, breakable to 110 mm, clear. Set with mini-cardholder in clear or black.

36200-00/xx



CHALK BOARD "FISH"

PVC slate 0,5 mm, both sides slate coated and printed with 1 color, size 130 x 100 mm, black. Further sizes and customized printing available upon request.

30102-0005/05



CHALK BOARDS

Made of polystyrene, both sides slate coated, for showcard frames of same size, thickness 0,95 mm, rounded edges, black.

Please note: These chalk boards are not heat-resistant. An exposure to direct sun light for example may lead to a deformation of the boards. For heat-resistant chalk boards see page 194.

A8		30012-A8/095
A7		30012-A7/095
A6		30012-A6/095

Other sizes available upon request.



CHALK BOARD MARKER

To directly write on chalk boards, water soluble, white. PU: 8 pcs. per size.

5 mm		24281-01
15 mm		24280-01



SHELF EQUIPMENT

DELICATESSEN & COUNTER MARKING



HOLDER FOR LAMINATED SIGNS
Bent PVC 0,5 mm, for signs up to max. 1 mm thickness, angle approx. 80° (suitable chalk boards please see page 303), PU: 50 pcs. in poly bag.

holder for laminated signs (55 x 43 x 20 mm) height 25 mm		29900-0003/05
(60 x 68 x 25 mm) height 70 mm		29900-0001/05
(60 x 68 x 70 mm) height: 90 mm		29900-0002/05
(60 x 68 x 90 mm)		29900-0004/05

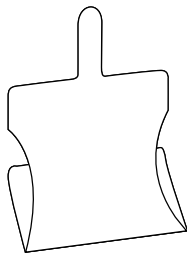

PVC L-SUPPORT
Suitable for price cassettes delicatessen A8 (or OEK Klick frames), clear. PU: 25 pcs.

5 cm		17211-00
10 cm		17210-00

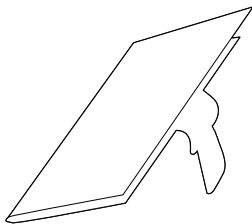

PVC SUPPORT
Suitable for price cassettes delicatessen A8 (or OEK Klick frames), used to give additional information at the rear for sales staff, label size 65 x 45 mm, clear. PU: 25 pcs.

17110-00

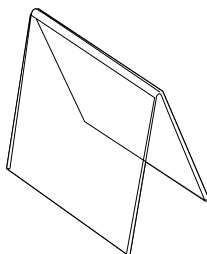

PVC COUNTER SUPPORT DOUBLE
For double sided insert of advertising or promotional price information, size 65 x 60 mm, made of bent PVC, clear. PU: 25 pcs.

29521-0006/10

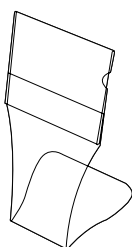

PVC COUNTER SUPPORT PORTRAIT
To insert advertising or promotional price information, size 65 x 60 mm, total height: 80 mm, made of bent PVC in slightly declined L-shape, clear. PU: 25 pcs.

29720-0006/10



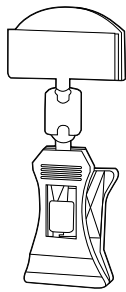

CARDHOLDER "VISION 27" WITH CLAMP

Set consisting of small cardholder 27 and small clamp 36 with connector.

without rod		28400-00
with rod 50 mm		28400-00/050
with rod 100 mm		28400-00/100

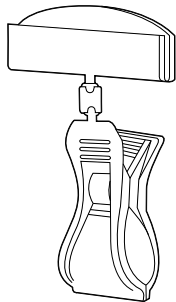

CARDHOLDER "VISION 50" WITH CLAMP

Set consisting of large cardholder 50 and big clamp 58 with connector.

without rod		28410-00
with rod 50 mm		28410-00/050
with rod 100 mm		28410-00/100

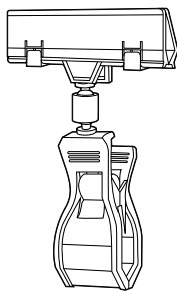

CLAMPHOLDER "VISION 80" WITH CLAMP

Set consisting of clampholder 80 and big clamp 58 with connector.

without rod		28420-00
with rod 50 mm		28420-00/050
with rod 100 mm		28420-00/100

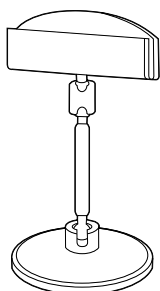

CARDHOLDER "VISION 50" WITH ROUND BASE

Set consisting of large cardholder 50 and round base Ø 50 with connector.

without rod		28430-00
with rod 50 mm		28430-00/050
with rod 100 mm		28430-00/100

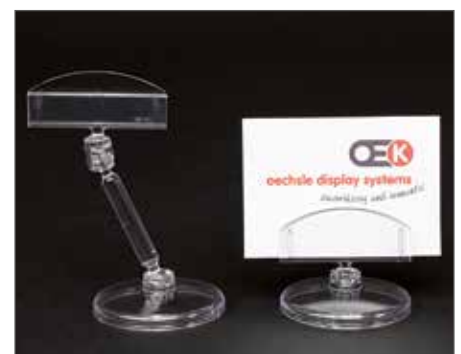

SHELF EQUIPMENT

DELICATESSEN & COUNTER MARKING

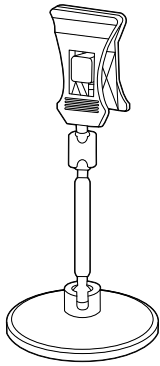

CLAMP "VISION 36" WITH ROUND BASE

Set consisting of small clamp 36 and round base Ø 50 with connector.

without rod		28435-00
with rod 50 mm		28435-00/050



CLAMP "VISION 36" WITH RECTANGULAR BASE

Set consisting of small clamp 36 and rectangular base 50 x 75 mm with connector.

without rod		28436-00
with rod 50 mm		28436-00/050

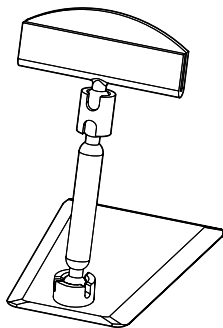

CARDHOLDER "VISION 50" WITH RECTANGULAR BASE

Set consisting of large cardholder 50 and rectangular base 50 x 75 mm with connector.

without rod		28440-00
with rod 50 mm		28440-00/050
with rod 100 mm		28440-00/100

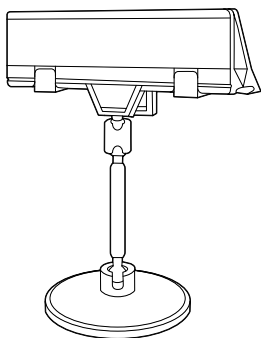

CLAMPHOLDER "VISION 80" WITH ROUND BASE

Set consisting of clampholder 80 and round base Ø 85 mm with connector.

without rod		28490-00
with rod 50 mm		28490-00/050
with rod 100 mm		28490-00/100



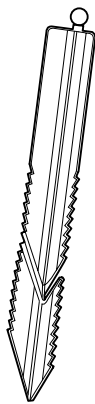

ICE-STICK 150 "VISION"

With Visionline ball joint for combination with cardholder and clampholder Vision, length 150 mm, breakable to 110 mm, clear.

28110-00

ICE-STICK "VISION 80" WITH CLAMPHOLDER

Set consisting of clampholder 80, Ice-Stick 150 Vision and connector.

28433-00

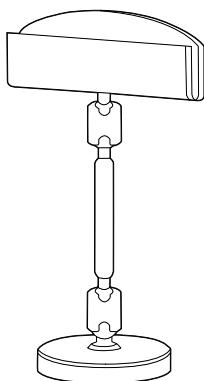

CARDHOLDER "VISION 50" WITH MAGNET

Set consisting of large cardholder 50 and big magnetic base Ø 32 mm with connector.

without rod		28470-00
with rod 50 mm		28470-00/050
with rod 100 mm		28470-00/100

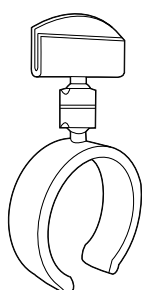

CARDHOLDER "VISION 27" WITH RING

Set consisting of small cardholder 27 mm clear with ring and connector white. For price marking right at the product (e.g. in sausages counters).

with ring 30 mm		28471-00/30
with ring 40 mm		28471-00/40
with ring 50 mm		28471-00/50
with ring 70 mm		28471-00/70
with ring 90 mm		28471-00/90



SHELF EQUIPMENT

DELICATESSEN & COUNTER MARKING

SIGNHOLDER SUPPORT SWIVEL-TYPE
Small support with cardholder 25 mm clear to take light signs, small cards, etc. with thickness up to 0,5 mm. Adjustable viewing angle. Size: 38 x 30 mm.

17020-00

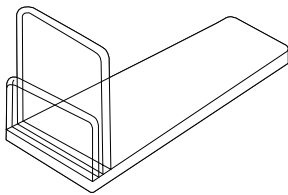

LYING CARDHOLDER

To hold small price and promotion cards, etc., slot width 0,5 mm. Size: 42 x 24 mm, clear.

36700-00



PLANT STICK 150 WITH CARDHOLDER

To stick into planting dish, rod with Klick adaptor length 150 mm breakable to 110 mm, set complete with cardholder, moss green.

36220-6005



PLASTIC STAKE 90 MM WITH CARDHOLDER FK

Set consisting of plastic stake 90 mm and cardholder FK, black for signs 0,1 - 0,8 mm thickness.

36300-26/10

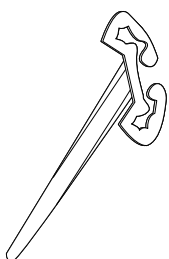

PLASTIC STAKE FOR PRICE CARDS

To fix small price and promotion cards, etc., with max. 1 mm material thickness, length approx. 50 mm, white.

23840-01





NEW

**CLAMPHOLDER FOR SIGNS,
60 X 45 MM**

To fix signs, not suitable for chalk boards.
Sizes approx. 4,5 x 6,0 cm (W x H). Color:
green. Other colors available upon
request. PU: 10 pcs.

17260-07

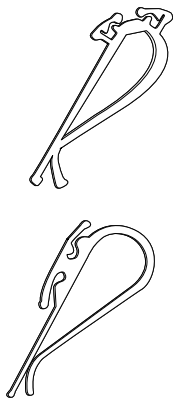

UNIVERSAL CLIP FOR PRICE CARDS

To fix small price and promotion cards,
chalk boards etc., with thickness up to
1 mm, onto delicatessen bowls max.
10 mm thick. Size: 15 x 60 mm, white.

inclined | 17250-01

upright | 17255-01

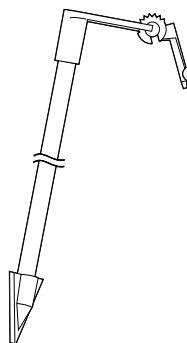

STAKE

Aluminium tube Ø 6 mm, in lengths 200,
400, 600 and 800 mm, other lengths avail-
able upon request. With plastic stake and
adjustable Klick adaptor. To be combined
with Klick shelf barkers, cardholder, etc.

stake 200 | 38401-91/6/200

stake 400 | 38401-91/6/400

stake 800 | 38401-91/6/800

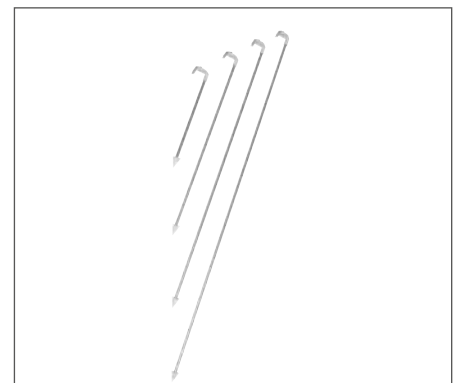

STAKE WITH CARDHOLDER

Aluminium tube Ø 6 mm in lengths 200,
400, 600 and 800 mm, other lengths
available upon request. With plastic stake
and cardholder grey.

stake 200 with cardholder | 36101-03/200

stake 400 with cardholder | 36101-03/400

stake 600 with cardholder | 36101-03/600

stake 800 with cardholder | 36101-03/800



SHELF EQUIPMENT

DELICATESSEN & COUNTER MARKING

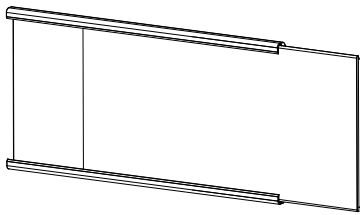

PRICE CASSETTE FOR FRUIT AND VEGETABLES 160 X 83 MM

Price cassette for printed inlays with clear cover (for pushing) for fruit and vegetables, with Klick adaptor for OEK Klick accessories as well as for accessories of other producers on rear side, colors: green, black.

71-13010-xx

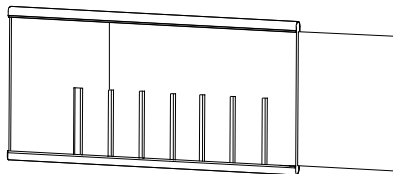

PRICE CASSETTE FOR FRUIT AND VEGETABLES 160 X 83 MM

Price cassette for printed inlays with clear cover (for pushing) for fruit and vegetables, with Klick adaptor for OEK Klick accessories as well as for accessories of other producers on rear side, assembled with numbers (slot 2-8), size 160 x 83 mm, colors: green, black.

numbers green on white, English or German		71-13100-xx/ENG or /DEU
numbers black on white, English or German		71-13110-xx/ENG or /DEU
numbers white on black, chalk style, English or German		71-13120-xx/ENG or /DEU



LOCKING LEVER AND BLANK LABELS FOR PRICE CASSETTES O+G 160X83 MM

1. DIGITS "ADDITIVES" FOR FRUIT AND VEGETABLES PRICE CASSETTE 160 X 83 MM
Digits "additives" for fruit and vegetables price cassette 160 x 83 mm, color: transparent, 20 sets / sheet.

print: white / chalk style, English or German		71-24130-01/ENG or /DEU
print: green, English or German		71-24130-07/ENG or /DEU
print: black, English or German		71-24130-10/ENG or /DEU

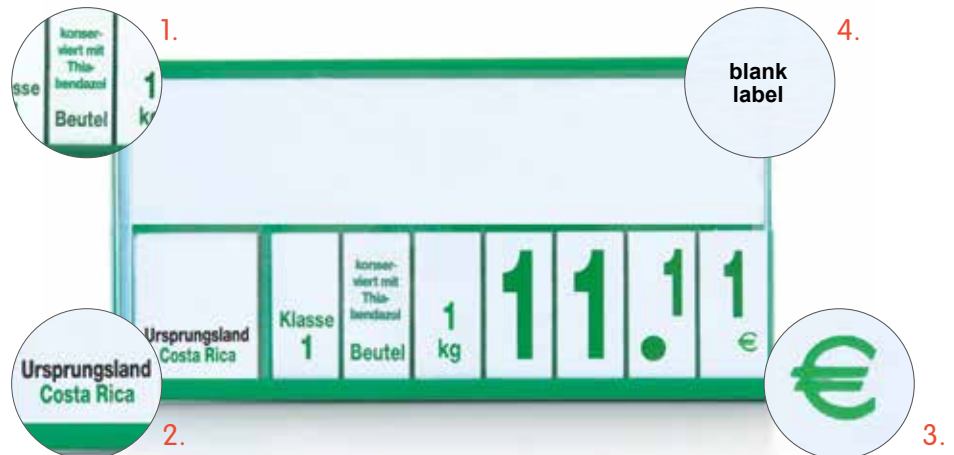

2. DIGITS "COUNTRIES OF ORIGIN" FOR FRUIT AND VEGETABLES PRICE CASSETTE 160 X 83 MM
Digits "countries of origin" for fruit and vegetables price cassette 160 x 83 mm (for slot 1), 4 sets / sheet

Leporello print: white on black, chalk style, English or German		71-24120-01/10/ENG or /DEU
Leporello print: green/black on white, English or German		71-24120-07/10/ENG or /DEU

3. €-SIGN FOR FRUIT AND VEGETABLE PRICE CASSETTE 160 X 83 MM
€-sign for fruit and vegetables price cassette 160 x 83 mm, color: transparent, 80 pcs. / sheet

print: white / chalk style		71-24110-01
print: green		71-24110-07
print: black		71-24110-10

4. BLANK LABELS FOR PRICE CASSETTES O+G 160X83
Blank labels can be marked and printed manually with the help of a corresponding software. (for laser printing only)
Size: approx. 155 x 40 mm.
Delivered on pre-cut A4 sheets.
Labels and software upon request.

71-24100-01



QP UNIVERSAL CLAMP

Very massive clamp to attach qP price cassettes, shelf barkers, etc. to boxes and baskets with thickness up to 30 mm. Klick adaptor with rotary ball-joint. Color: black.

17070-10

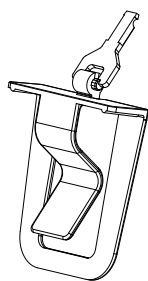

CARDBOARD CLAMP 70 WITH FK CONNECTOR 25

To attach onto baskets, boxes, etc., for material thickness up to 18 mm. Set consisting of cardboard clamp 70 and FK connector 25.

Color: black.
Other colors available upon request.

35490-10

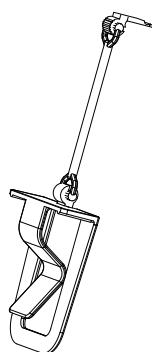

CARDBOARD CLAMP 70 WITH FK ROD

To attach onto baskets, boxes, etc., for material thickness up to 18 mm. Set consisting of cardboard clamp 70 and FK rod with Klick adaptor for combination with price cassettes, Klick shelf barkers, acrylic frames, ESL and many others.

Color: black.
Other colors available upon request.

- with rod 50 mm | 35492-10/050
- with rod 100 mm | 35492-10/100
- with rod 200 mm | 35492-10/200



PRICE DISPLAY PD 210 X 190 MM

Designed to be used at fruit and vegetable shelves, for 6-digit folded number strips, front with 2 inserts for wording (top 40 x 190 mm, bottom 55 x 190 mm), rear with additional adaptor for Klick accessories, color: green. Supplied without number strips, cutting for wording and PVC cover.

14280-07



FOLDED NUMBER STRIPS FOR PD A5 & PD 210 X 190 MM

Made of white PVC, printed black with small and large numbers, sheet size 418 x 180 mm with 6 strips 418 x 30 mm each.

24056-00

SHELF EQUIPMENT

DELICATESSEN & COUNTER MARKING / SIGNHOLDER



SINGLE PLASTIC CASSETTE FOR SPIRAL BOUND NUMBER BLOCKS
Single plastic cassettes made of white polystyrene to create individual displays. Individual combinations are welded to PS boards with customized printing and additional plastic rails or PVC covers for promotional information. Single or double sided versions possible.

Single Cassette

40 x 80 mm | 24630-01
72 x 80 mm | 24620-01
76 x 181 mm | 24610-01

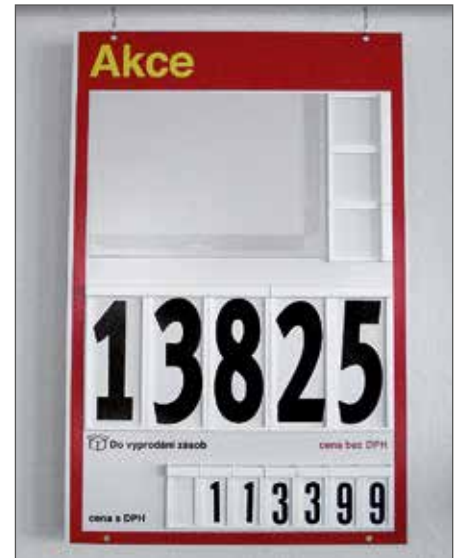

PLASTIC CASSETTE FOR SPIRAL BOUND NUMBERS

Cassette made of polystyrene white, to create individual displays.

Cassette with each 5 inserts

203 x 93 mm | 24341-01
203 x 125 mm | 24342-01
290 x 170 mm | 24343-01
410 x 225 mm | 24344-01
296 x 125 mm (5+1 insert) | 24345-01

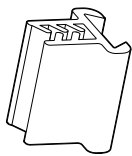

KLICK GRIP 15

Suiting the range of the Klick accessories (series 300) this Klick grip is creating a super signholder range with fixing possibilities for almost every situation. Simply to put onto the dovetail guide of the various Klick elements - done.

To take signs, crowners etc. with a max. thickness of 2 mm. Color: clear. PU: 100 pcs.



28003-00/0015

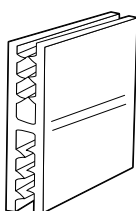

DOUBLE HOLDER SUPERGRIP

"H" version to connect 2 signs, cards, crowners, etc. with up to 2 mm thickness, length 25 mm, clear. PU: 100 pcs.

28014-00/25

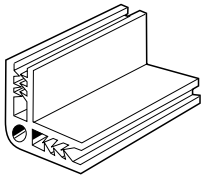

L HOLDER SUPERGRIP
"L" version (90° angle) to connect 2 signs, cards etc. with up to 2 mm thickness, length 25 mm, clear. PU: 100 pcs.

28020-00

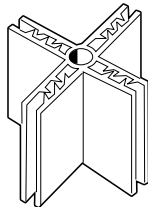

X HOLDER SUPERGRIP
"X" version (90° angle) to connect up to 4 signs, cards etc. with up to 2 mm thickness, length 25 mm, clear. PU: 100 pcs.

28019-00

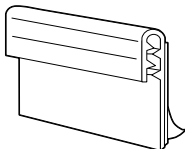

SIGNHOLDER SUPERGRIP
To take signs, crowners, cards, etc. with up to 2 mm thickness parallel to the shelf, self adhesive, clear. PU: 100 pcs.

length 25 mm | 28015-00/25
length 75 mm | 28015-00/75



SIGNHOLDER FOR WIRES SUPERGRIP
To fix onto wires with up to Ø 7 mm, to take signs, crowners, cards, etc. with up to 2 mm thickness, clear. PU: 100 pcs.

28016-00/13

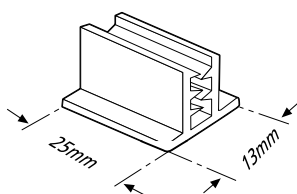

DISPLAY HOLDER SUPERGRIP
To take signs, crowners, cards, etc. with up to 2 mm thickness, self adhesive, clear. PU: 100 pcs.

length 25 mm | 28013-00/25
length 75 mm | 28013-00/75

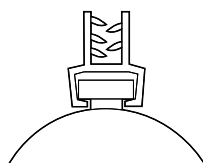

SIGNHOLDER SUPERGRIP 25 MM WITH SUCTION CUP
Parallel, to take material with 0,2 - 1,3 mm, color: clear.

28024-00



SHELF EQUIPMENT

ACCESSORIES FOR PEG-BOARD HOOKS

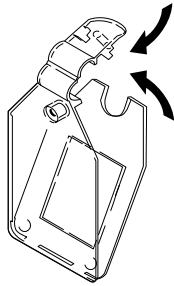

POCKET SWING TAG FOR PEG BOARD HOOKS

Pocket swing tag for peg board hooks, suitable for wire-Ø 4,8 mm. With clear snap pocket. PU: 100 pcs.

25 x 27 mm | 17301-00
25 x 38 mm | 17300-00

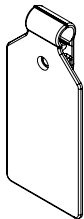

POCKET SWING TAG FOR PEG BOARD HOOKS

Pocket swing tag for peg board hooks, suitable for wire-Ø 4,8 mm, for use with adhesive labels only. Color: white. PU: 100 pcs.

for label size 25 x 25 mm | 17305-01
for label size 25 x 38 mm | 17304-01

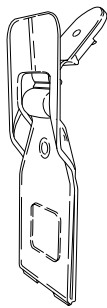

POCKET SWING TAG FOR DOUBLE HOOKS WITH ANTI-THEFT SYSTEM

Pocket swing tag for double hooks with anti-theft system 26 x 68 mm (suitable for wire-Ø 4,8 mm). Cost-saving anti-theft system for quality goods. With pocket for labels size 25 x 27 mm (W x H). PU: 100 pcs.

17320-00

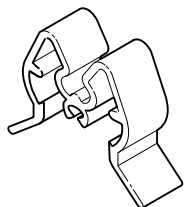

STOCK INVENTORY CLIP

Stock inventory clip for slatwall hooks, fitting onto single or double hooks with wire- Ø 4,8 mm, white. PU: 100 pcs.

49991-01



PENDULUM POCKET DRA 26

Scanner profile for peg board hooks with wires Ø 4,8 mm, 7 mm punching, for labels size 26 x 75 mm, clear. Other sizes available upon request. PU: 100 pcs.

49361-00/0075



PENDULUM POCKET DRA 39

Scanner profile for peg board hooks with wires Ø 4,8 mm, 7 mm punching, for labels size 39 x 75 mm, clear. Other sizes available upon request. PU: 100 pcs.

49364-00/0075





GLS 39
Scanner rail for 39 mm labels, to fix onto glass shelves up to 10 mm thickness.
Color: clear. PU: 10 pcs.

shelf length 1000 mm | 49604-00/0998
shelf length 1250 mm | 49604-00/1248



Standard colors: transparent, white (similar to RAL 9010).
Other colors available upon request.
All our scanner rails are supplied without grip edge (except for TEC 39).

HE 39
Scanner rail for 39 mm labels, with double adhesive tape (or foam adhesive tape with white and colored rails) and angle.
PU: 10 pcs.

shelf length 1000 mm | 49124-xx/0998
shelf length 1250 mm | 49124-xx/1248

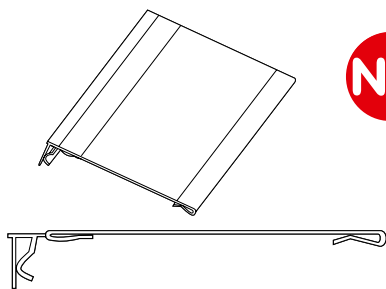

PARALLEL SHOPPER STOPPER WITH HINGE
To fix into scanner rails, color: clear.

A7 (landscape) | 49500-00/0105
148 x 110 mm (landscape) | 49501-00/0148
298 x 110 mm (landscape) | 49501-00/0298
A6 (portrait) | 49502-00/0105



DBH 39 WIRE
Scanner rail for 39 mm labels for wire baskets and containers, (clips to be ordered separately). PU: 50 pcs.

49314-xx/0980



CLIP FOR DBH 39 WIRE RAIL
To fix scanner rail DBH 39 onto wire shelves, wire baskets or similar, length 50 mm, white.

49999-11

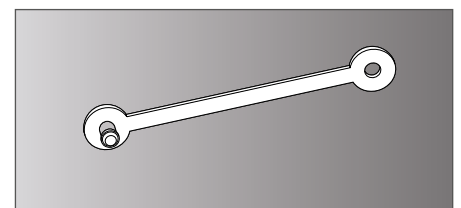

FOL 39
Colored inlay strip for 39 mm scanner rails in grey (similar to RAL 7035), yellow (similar to RAL 1018), orange (similar to RAL 2008), red (similar to RAL 3027), blue (similar to RAL 5005), green (similar to RAL 6029).
Further colors available upon request.
PU: 1 roll/100 m.

25658-xx



SHELF EQUIPMENT

SCANNER RAILS

Standard colors: transparent, white (similar to RAL 9010).

Other colors available upon request.

All our scanner rails are supplied without grip edge (except for TEC 39).

DBR 26

Scanner rail for 26 mm labels, with double adhesive tape (or foam adhesive tape with white and colored rails). PU: 10 pcs.

shelf length 1000 mm | 49101-xx/1000
shelf length 1250 mm | 49101-xx/1250



DBR 30

Scanner rail for 30 mm labels, with double adhesive tape (or foam adhesive tape with white and colored rails). PU: 10 pcs.

shelf length 1000 mm | 49102-xx/1000
shelf length 1250 mm | 49102-xx/1250



DBR 39

Scanner rail for 39 mm labels, with double adhesive tape (or foam adhesive tape with white and colored rails). PU: 10 pcs.

shelf length 1000 mm | 49104-xx/1000
shelf length 1250 mm | 49104-xx/1250



DBR 52

Scanner rail for 52 mm labels, with double adhesive tape (or foam adhesive tape with white and colored rails). PU: 10 pcs.

shelf length 1000 mm | 49105-xx/1000
shelf length 1250 mm | 49105-xx/1250



LS 26

Scanner rail for 26 mm labels, to clamp (in 2 angles) onto Tego, Linde, Storebest or other shelves with similar front groove. PU: 10 pcs.

shelf length 1000 mm | 49321-xx/0988
shelf length 1250 mm | 49321-xx/1238



SHELF EQUIPMENT

SCANNER RAILS

Standard colors: transparent, white (similar to RAL 9010).

Other colors available upon request.

All our scanner rails are supplied without grip edge (except for TEC 39).

LS 39

Scanner rail for 39 mm labels, to clamp (in two angles) onto Tego, Linde, Storebest or other shelves with similar front groove.

PU: 10 pcs.

shelf length 1000 mm | 49324-xx/0988

shelf length 1250 mm | 49324-xx/1238

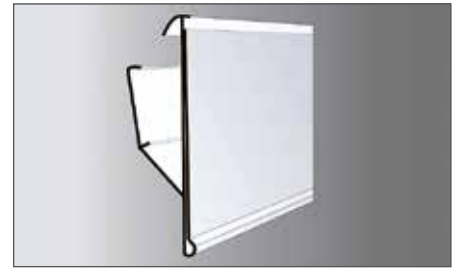

TE 30

Scanner rail for 30 mm labels, to clamp onto Tego or other shelves with similar front groove. PU: 10 pcs.

shelf length 1000 mm | 49332-xx/0989

shelf length 1250 mm | 49332-xx/1238



TE 39

Scanner rail for 39 mm labels, to clamp onto Tego or other shelves with similar front groove. PU: 10 pcs.

shelf length 1000 mm | 49334-xx/0989

shelf length 1250 mm | 49334-xx/1238



TEC 39

Scanner rail for 39 mm labels, with grip edge to clamp onto Tego or other shelves with similar front groove. PU: 10 pcs.

shelf length 1000 mm | 49434-xx/0989

shelf length 1250 mm | 49434-xx/1238



KE 39

Scanner rail for 39 mm labels, for wire shelvings, inclined 25° position. PU: 10 pcs.

shelf length 1000 mm | 49344-xx/0980

shelf length 1250 mm | 49344-xx/1238



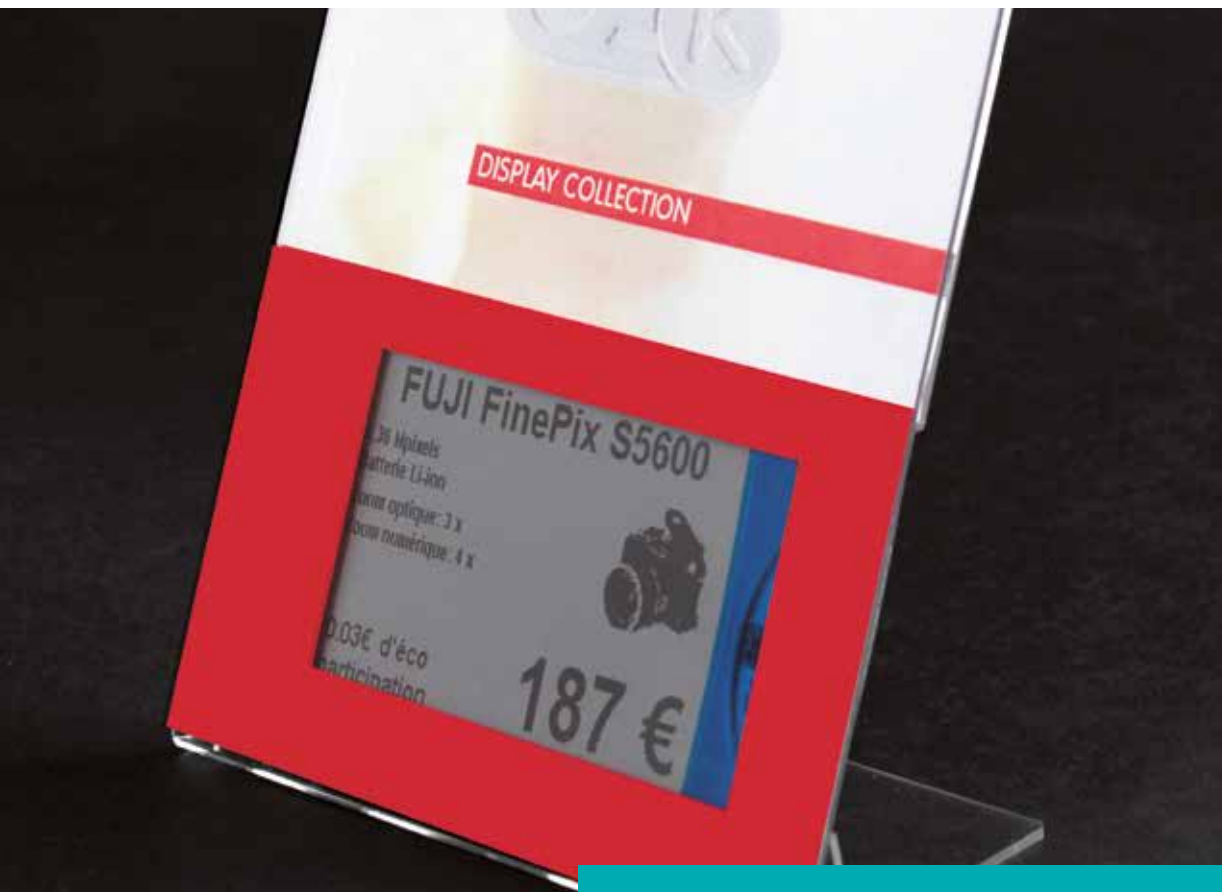

ELECTRONIC SHELF MARKING

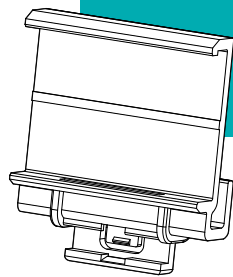

ELECTRONIC SHELF MARKING

FASTENERS FOR ELECTRONIC PRICE LABELS

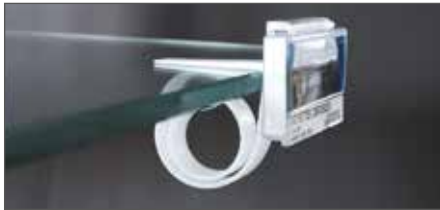

ELECTRONIC PRICE LABELING – WITH THE PROVEN KLICK ADAPTORS MADE BY EXPERTS!

All fasteners from our ESL series are suitable for price labels of other brands such as for ex. PRICER, "SOLU M" [Samsung], Delfi [Displaydata] and SES-IMAGOTAG. We are constantly developing new application possibilities that perfectly meet the needs of the market. So if you have any particular requirements, please do not hesitate to contact us.

Advantages of OEK fasteners:

- + Easy and quick to mount
- + Flexible, to highlight sales campaigns or additional information
- + No additional cover that reduces legibility
- + Various fastening possibilities thanks to the Oechsle Klick accessories
- + In addition to standardized serial products OEK also develops individual custom-made solutions

OEK ESL-fasteners are used in:

- + Pharmacies
- + Drugstores
- + Foodstuffs wholesalers and retailers
- + Health-food shops
- + Beverage stores
- + Petrol station shops
- + Electronics stores
- + Hardware stores
- + Shops for two-wheelers

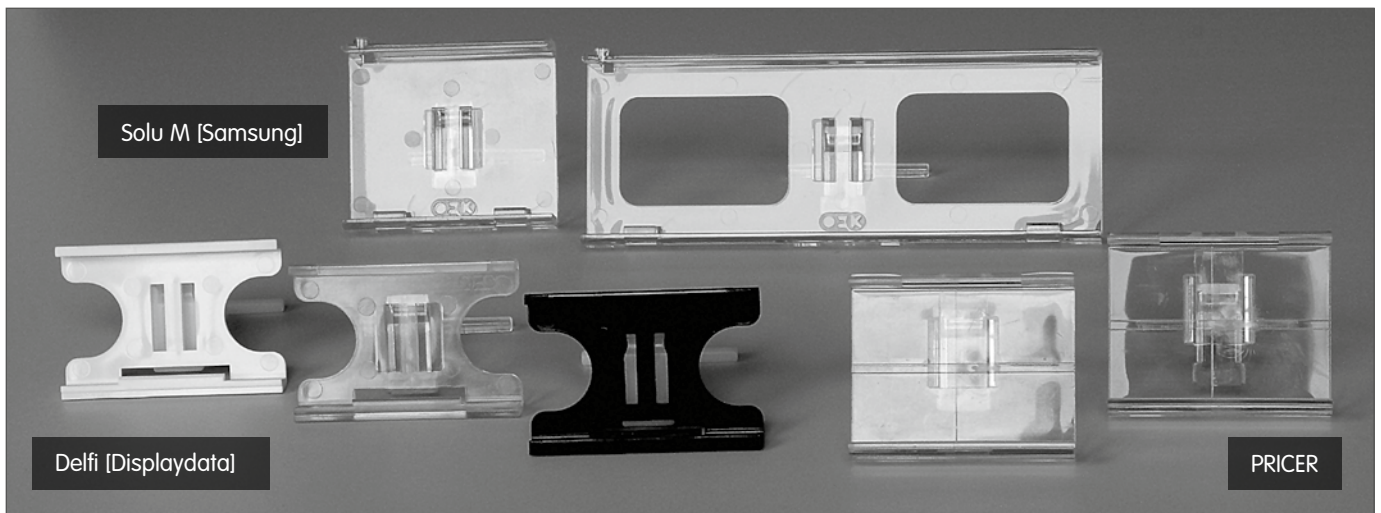

Thanks to several standard product variants we can provide the perfect solution for many different applications:

- Universal fastener (in combination with the Oechsle Klick accessories)
- Fastener for peg-board hooks
- Fastener for wires and round material
- Fastener for scanner rails
- Fastener for glass boards
- Fastener for wire boards (Wire Tech)



ELECTRONIC SHELF MARKING FOR PRICER LABELS

OEK KLICK ACCESSORIES – THAT'S HOW IT WORKS

The ESL universal fasteners by OEK are equipped with a Klick adaptor at the rear.

The Klick accessories elements for fixing the fasteners are inserted into the dove tail guide; once latched with a click, they are locked into place properly.

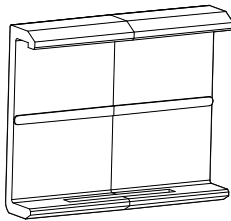

UNIVERSAL FASTENER

For PRICER series SmartTAG-, SmartTAG HD labels sizes S, M, L (as well as S and M labels of Continuum- and DotMatrix series). Color: clear, other colors upon request. Suitable accessories: series 300.

28705-00

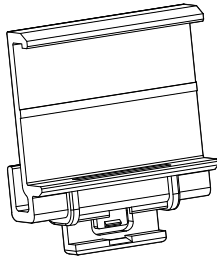

FASTENER FOR SCANNER RAILS

For PRICER series see universal fastener. Suitable for most scanner rails in use. Without disturbing cover. Color: clear.

28710-00



KEY FOR DISASSEMBLING

...of the scanner rail fastener. To unlock fastener and remove the label from the fastener.

28799-00



PRICER "Smart Tag"



PRICER "Continuum"



PRICER "DotMatrix"

ELECTRONIC SHELF MARKING

FOR PRICER LABELS



ACRYLIC SUPPORT FOR PRICER DM 200 C

L-support made from 3 mm acrylic, bent, with 4 holes to suit threaded inserts of price tag PRICER DM 200 C. Available upon request.

28791-00



PET-SUPPORT FOR PRICER SMARTTAG HD 110

L-support made from 1 mm PETG (bent, 30°). With punched Klick adaptor suitable to attach PRICER SmartTAG HD 110 or Dot Matrix 110. Can be used in either portrait or landscape position of price tag. Available upon request.

28790-00



KL-STAND WITH KLIKK ADAPTOR
Base in grey, aluminium tube Ø 6 mm.
Lengths: 200 and 400 mm.

KL stand 200 | 38400-91/6/200
KL stand 400 | 38400-91/6/400



KL-STAND WITH KLIKK ADAPTOR
Base in grey, aluminium tube Ø 6 mm.
Length: 300 mm.

38390-91/6/300



ELECTRONIC SHELF MARKING FOR "SOLU M" [SAMSUNG]

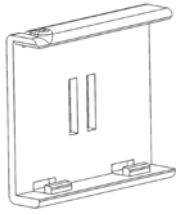

UNIVERSAL FASTENER 52 MM
For "SOLU M" (Samsung) series "Segment Tags Small". Fastener with rear Klick adaptor. Label width: 52 mm. Color: clear.

28706-00

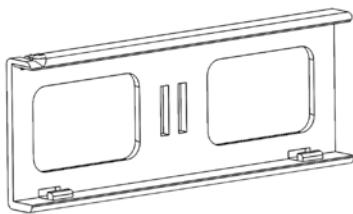

UNIVERSAL FASTENER 125 MM
For "SOLU M" (Samsung) series "Segment Tags Large". Fastener with rear Klick adaptor. Label width: 125 mm. Color: clear.

28708-00

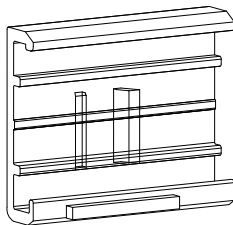

UNIVERSAL FASTENER FOR MODEL
ST-GR2900N
For "SOLU M" (Samsung) series
ST-GR2900N. Fastener with rear Klick
adaptor. Color: clear.

28703-00

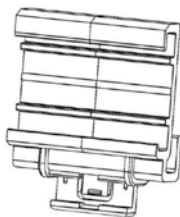

FASTENER FOR SCANNER RAILS
For "SOLU M" (Samsung) series
ST-GR2900N, 2-parts. Consisting of fastener
and locking bar. Suitable for most scanner
rails in use. Color: clear.

28704-00



ELECTRONIC SHELF MARKING

FOR SES-IMAGOTAG AND DELFI [DISPLAYDATA]

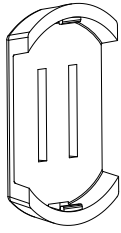

UNIVERSAL FASTENER

For SES-IMAGOTAG series G1, 1,6" with round battery case. Fastener with rear Klick adaptor. Color: clear.

28709-00



CLICK ADAPTOR AND ACCESSORIES FOR SES-IMAGOTAG LABELS

For series G1 2.0" and G1 2.7", SES-IMAGOTAG provides an adaptor with Klick adaptor.

The adaptor is – similar to the OEK universal fastener – pushed on the back of the cassette. This connector allows you to use the OEK fastener for glass and wire shelves, wires, perforated wall hooks and scanner rails as usual.

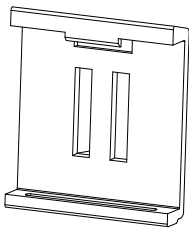

UNIVERSAL FASTENER

For DELFI (DISPLAYDATA) series "Chroma 16". Fastener with rear Klick adaptor. Color: clear.

28702-00

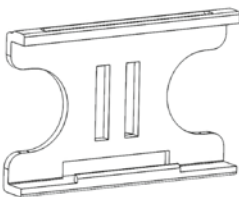

UNIVERSAL FASTENER

For DELFI (DISPLAYDATA) series "epop 50", "epop 55" as well as "Aura" and "Chroma". Fastener with rear Klick adaptor. Colors: clear, white, black.

28701-xx

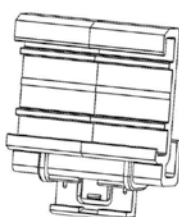

FASTENER FOR SCANNER RAILS

For DELFI (DISPLAYDATA) series "Aura" and "Chroma". 2-parts. Consisting of fastener and locking bar. Suitable for most scanner rails in use. Color: clear.

28712-00



ELECTRONIC SHELF MARKING

FOR GLASS-, WIRE BOARDS & SCANNER RAILS

Suitable for the OEK universal fasteners for the brands PRICER, "SOLU M" (Samsung) and Delfi (Displaydata).

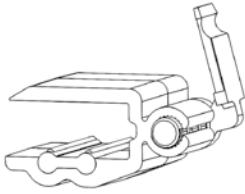

FASTENER FOR GLASS BOARDS
To be attached to glass boards with a thickness of 10 mm. With rubber inlay for a safe hold.

28719-00

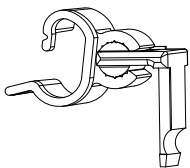

FASTENER FOR WIRE SHELVES
To be attached to wire shelves "Wire Tech" and "Wire Tech 100" (Wanzl). Inclination adjustable in 5 steps. Colors: POM grey/PC clear, POM black/PC clear. Other colors upon request.

23090-xx

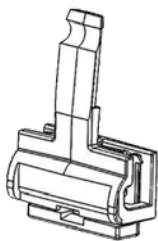

KLICK RAIL ADAPTOR WITH LOCK
Fastener to be attached to scanner rails. 2-parts. Color: clear.

28750-00

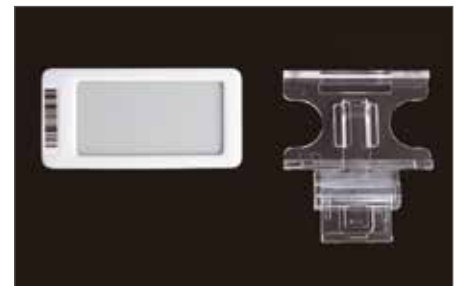

Example: Delfi Aura label with Delfi universal fastener and a Klick rail adaptor with lock.



ELECTRONIC SHELF MARKING

FOR PEG-BOARD HOOKS

Suitable for the OEK universal fasteners for the brands PRICER, "SOLU M" [Samsung] and Delfi [Displaydata].

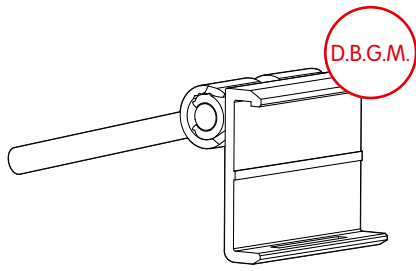

FASTENER FOR PEG BOARD HOOKS
With locking function to secure a certain viewing angle, 2-parts, color: transparent.

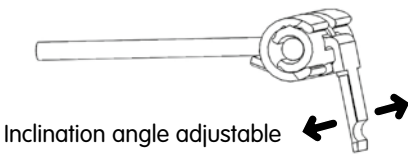
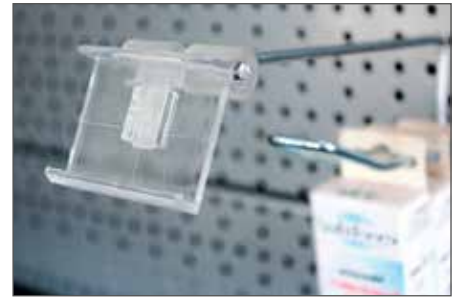

VERSION "A"
For hooks with front wire (e.g. Geck, ZOK and partly TEGO).

28718-00 A

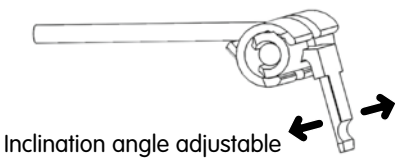

VERSION "B"
For hooks with bottom wire (e.g. Hohage, Wanzl and TEGO).

28718-00 B



KLICK FASTENER "SLOT" VERSION
For fixation to peg board hooks or to wires and round materials with a diameter from 4 to 6 mm.
Due to the weight of the ESL the fastener swings automatically into a vertical position – see picture on the right. Color: transparent.

23080-00



ELECTRONIC SHELF MARKING

OEK KLICK ACCESSORIES (SERIES 300)

Color code: 00= transparent, 01=white, 03=grey

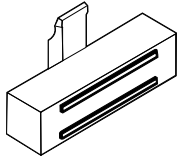

MAGNETIC FASTENER
HORIZONTAL
Color: 00
23225-00

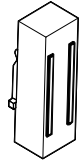

MAGNETIC FASTENER
VERTICAL
Colors: 00, 01, 03
23220-xx

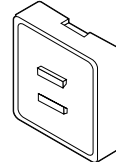

MAGNETIC FASTENER
SQUARE
Color: 01
21240-01

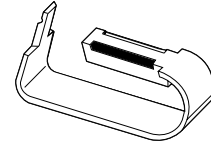

MAGNETIC SWING
FASTENER
Color: 01
23125-26

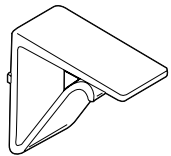

FASTENER FOR LEDGES
Color: 01
23160-26

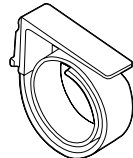

COIL-SPRING FASTENER
Color: 01
23100-26

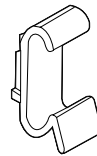

CLIP FASTENER FOR
TEGO SHELF
Color: 01
23610-26

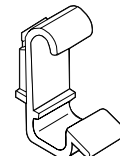

CLIP FASTENER FOR
LINDE SHELF
Color: 01
23620-26

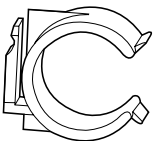

TUBE CLIP Ø 23-28 MM
Color: 01
23500-26

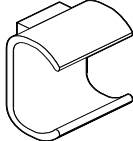

OVAL TUBE CLIP
Color: 00
23510-00



FASTENER FOR VERTICAL
METAL PLATES
Color: 01
23330-26



FASTENER FOR VERTICAL
GLASS PANELS
Color: 01
23320-26

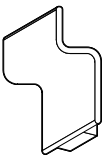

SLATWALL-CLIP
Color: 01
23780-26

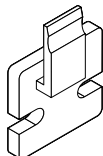

WALL FASTENER
Color: 01
23130-26

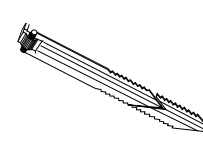

ICE STICK "KLICK"
Color: 00
23065-00

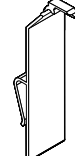

CARDBOARD CLAMP 10
Color: 00
23710-00



CARDBOARD CLAMP 20
Color: 00
23715-00



VISIONLINE-KLICK-ADAPTOR
WITH CLAMP "VISION 58"
Color: 00
28437-00

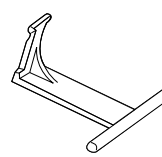

SUPPORT
Colors: 00, 01
23750-xx

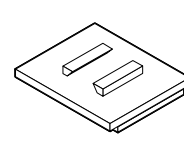

ADHESIVE PLATE
Color: 01
23150-01

ELECTRONIC SHELF MARKING

SUPPORTS FOR SHELVING AND COUNTERS

Suitable for usage with the OEK universal fasteners made for the brands PRICER, "SOLU M" (Samsung) and Delfi [Displaydata].

Color codes: 00=transparent, 01=white, 10=black

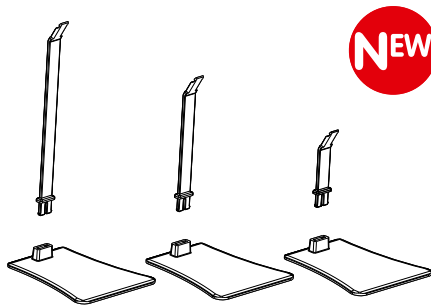

NEW

FK-FIX BASE

Colors: transparent, white, black.

FK-Fix base | 23970-xx

FK-FIX ROD

Colors: transparent, white, black.

FK-Fix rod 50 mm | 23975-xx

FK-Fix rod 100 mm | 23977-xx

FK-Fix rod 150 mm | 23979-xx

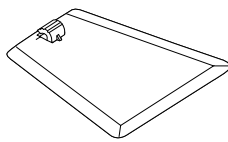
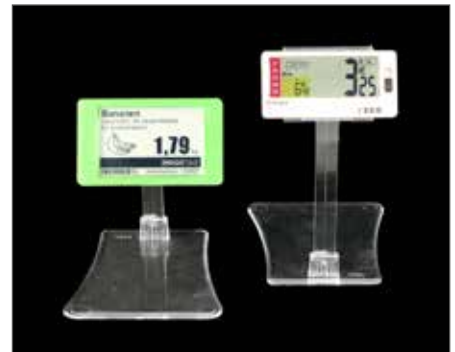

FK BASE

Colors: transparent, white, black.

FK base | 23900-xx

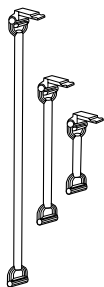

FK ROD

Colors: transparent, white, black.

FK rod 50 mm | 23905-xx

FK rod 100 mm | 23910-xx

FK rod 150 mm | 23920-xx



ACRYLIC L DISPLAY WITH LABEL HOLDER

Example image for a combined solution with insertion of an ESL label and a text inserter (see white box). Material: acrylic, bent, laser contoured. Upon request.



QP UNIVERSAL CLAMP

With Klick adaptor. Color: black.

17070-10



ELECTRONIC SHELF MARKING

ESL CARDBOARD CLAMPS

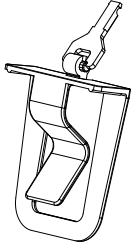

NEW

CARDBOARD CLAMP 70 WITH FK CONNECTOR 25

To be fixed to baskets and boxes up to a thickness of 18 mm material strength. Set consisting of cardboard clamp 70 and FK connector 25. Color: black. Other colors available upon request.

35490-10

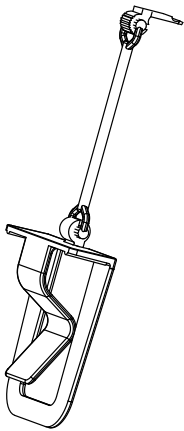

NEW

CARDBOARD CLAMP 70 WITH FK ROD

To be fixed to baskets and boxes up to a thickness of 18 mm material strength. Set consisting of cardboard clamp 70 and FK rod with Klick adaptor to be combined with price cassettes, Klick frames, acrylic frames, electronic shelf labels and others. Color: black.

Other colors available upon request.

with rod 50 mm		35492-10/050
with rod 100 mm		35492-10/100
with rod 200 mm		35492-10/200





CHECKOUT AND SALES MARKING

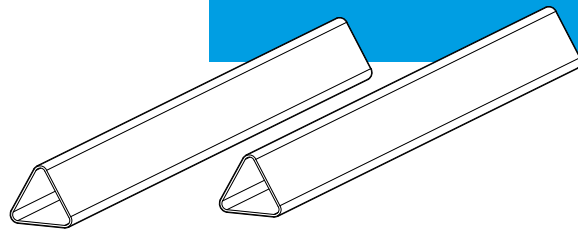

CHECKOUT AND SALES MARKING

CHECKOUT DIVIDERS

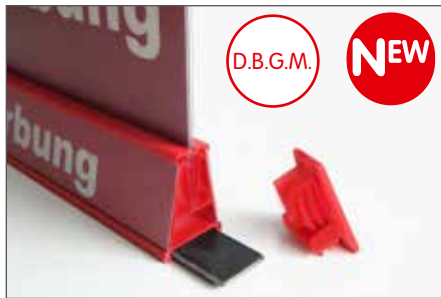

CHECKOUT DIVIDER TRAPEZOIDAL
Measurements (L x H x D): 305 x 140 x 35 mm.
Advertising opportunity on the flanks.
U-pockets are possible. Optionally
available with metal plate.
Colors and lengths upon request.
Available upon request.



CHECKOUT DIVIDER 30 X 30 MM RED
Measurements (LxHxD): 30x30x310 mm.
Advertising possibility with inserts size
309 x 23 mm. Incl. 2 end caps and 3 PVC-
strips transparent. Overlaying round edges
protect the divider from getting scratched.
Further colors and lengths upon request.

37010-00/310

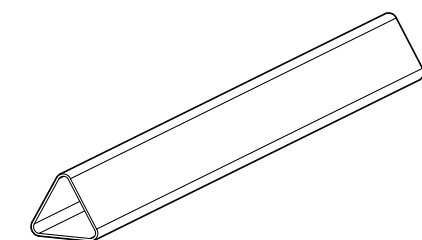

**CHECKOUT DIVIDER 30 X 30 MM
TRANSPARENT**
Measurements (L x H x D): 30 x 30 x 310 mm.
Advertising possibility with inserts. Other
colors and lengths upon request. End caps
to be ordered separately.

88-37000-00/300

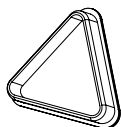

END CAP FOR CHECKOUT DIVIDER
To be put and glued sideways into the
checkout divider profile. Colors: white,
rape yellow, red, black. Further colors
available upon request.

84-15499-xx



**END CAP LARGE FOR CHECKOUT
DIVIDER**
To be stucked outside onto the divider.
Divider is laying only on the edges of the
end caps. Advantage: divider does not get
scratched. Colors: white, traffic red.

84-15497-xx



End caps are
protecting the divider
from getting scratched.

CHECKOUT AND SALES MARKING

CHECKOUT DIVIDERS/CASH TRAYS

CHECKOUT DIVIDER "WOOD"

Made of pure oak. Measurements: 300 x 30 x 30 mm. Individual logo print available upon request.

rectangular | 37021-00
triangular | 37020-00



CHECKOUT DIVIDER T

Made of massive wood natural beech with T-profile slot and 3 supergrips (to be inserted sideways), incl. 0,5 mm clear PVC poster protector 297 x 140 mm.

37030-00



CASH TRAY "WOOD"

Square cash tray made of pure oak, concave shaped with stoppers for a non-slip stand. Measurements: 140 x 140 x 20 mm. Individual logo print available upon request.

13289-00



CASH TRAY "K" 215 X 100 MM

Bended cash tray made of 2 mm acrylics with rubber pads for a non-slip stand. Insert (bottom size max. 96 x 215 mm - complete size max. 190 x 215 mm) available upon request, transparent.

13288-00



CASH TRAY "K" 205 X 170 MM

Cash tray made of high-grade unbreakable plastics with round corners and rubber pads for a non-slip stand. No inlay (adhesive foil or paper inlay), transparent.

13281-00

Individual print available upon request.



CHECKOUT AND SALES MARKING

CASH TRAYS

CASH TRAY "GLASS" 150 X 150 MM
Cash tray made of glass with round corners, round cash hollow and stoppers for a non-slip stand, crystal clear. No inlay.

13285-00

Individual print available upon request.



CASH TRAY "K" 180 X 180 MM
Cash tray made of high-grade unbreakable plastics, concave shaped with mitred corners and stoppers for a non-slip stand, transparent. No inlay.

13290-00

Individual print available upon request.



CASH TRAY WITH PRODUCT PRESENTATION

Cash tray with can display. For other products upon request. Material: acrylic, laser contour. Measurements: 355 x 249 x 106 mm. Other measurements upon request.

With elastic buffer on the bottom.
Text inlay included.

Available upon request.

Individual print available upon request.



REMARK:
Further types in different versions available upon request.



INFOLINE

The products from our series "INFOLINE" have been successfully used – for years! Wherever you need to display lots of information in a space saving way, INFOLINE is the best choice. Offering high quality, precise workmanship as well as a comprehensive standard range for increased flexibility this system provides the ideal solution for every application.

All INFOLINE "400" models with 5 delicate INFOLINE frames are equipped with a black plastic rear permitting to fix the frames in 3 different heights. The models with 10 frames are supplied with a grey metallic rear (not adjustable in height).

REMARK:

All SK bases are supplied with 2 hole drillings. For increased stability we recommend screwing them onto the desk.



INFOLINE W A4

For wall fixing, with 5 or 10 Infoline frames A4 in OEK standard colors or multicolored (color code = 00), incl. non-reflective PVC poster protectors, plastic rear black (for 10 frames metallic rear in grey). Total height 33 cm.

with 5 frames		39640-xx/5
with 10 frames		39640-xx/10



INFOLINE W WITH 5 FRAMES

For wall fixing, with 5 frames A5 in OEK standard colors or multicolored (color code = 00), incl. non-reflective PVC poster protectors, rear with 2 plastic profile angles black and aluminium connector. Total height 24 cm.

A5		39650-xx/5
A3		39630-xx/5



INFOLINE T

With 7 or 10 Infoline frames A4 in OEK standard colors or multicolored (color code = 00), incl. non-reflective PVC poster protectors, metallic L-shape stand, black. Total height: 35 cm.

with 7 frames		39200-xx/7
with 10 frames		39200-xx/10



CHECKOUT AND SALES MARKING

INFOLINE



INFOLINE T PLEXI

With 5 Infoline frames A4 in OEK standard colors or multicolored (color code = 00), incl. non-reflective PVC poster protectors, transparent plastic stand for use as table or counter version.

with 5 frames | 39250-xx/5

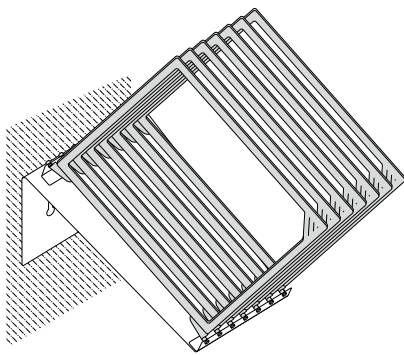

INFOLINE T/W A4

Infoline stand for table or wall, with 8 Infoline frames A4 in OEK standard colors or multicolored (color code = 00), incl. non-reflective poster protectors, metallic support grey inclined, L-shape. Total height: 30 cm.

with 8 frames | 39194-xx/8

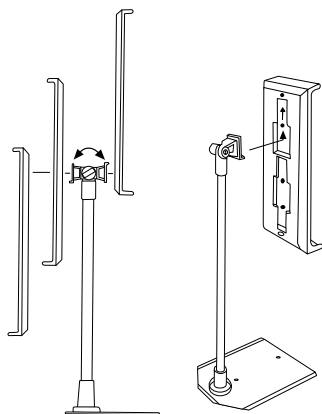

INFOLINE 401

With 5 or 10 Infoline frames A4 in OEK standard colors or multicolored (color code = 00), incl. non-reflective PVC poster protectors, SK base black, fixed aluminium tube 38 cm, 1 hinge with locking screw on the back.

with 5 frames | 39445-xx/5
with 10 frames | 39445-xx/10



INFOLINE 402

With 5 or 10 Infoline frames A4 in OEK standard colors or multicolored (color code = 00), incl. non-reflective PVC poster protectors, SK base black, fixed aluminium tube 38 cm, 2 hinges with locking screw (on the back and on base level).

with 5 frames | 39465-xx/5
with 10 frames | 39465-xx/10



INFOLINE 400A

With 5 or 10 Infoline frames A4 in OEK standard colors or multicolored (color code = 00), incl. non-reflective PVC poster protectors, SK base black, adjustable aluminium tube 40 - 70 cm, 1 hinge with locking screw on the back.

with 5 frames | 39405-xx/5
with 10 frames | 39405-xx/10



INFOLINE BD

With 5 Infoline frames A4 in OEK standard colors or multicolored (color code = 00), incl. non-reflective PVC poster protectors, BD base Ø 255 mm black, fixed aluminium tube 120 cm. Total height: 145 cm.

Infoline BD | 39490-xx/5



INFOLINE 500

With 5 frames A5 in OEK standard colors or multicolored (color code = 00), with extra browser clips, incl. non-reflective PVC poster protectors, SK base black, fixed aluminium tube 20 cm, 1 hinge with locking screw underneath the back. Total height: 52 cm.

Infoline 500 | 39500-xx/5



CHECKOUT AND SALES MARKING

INFOLINE

INFOLINE 300

With 5 frames A3 in OEK standard colors or multicolored (color code = 00), with extra browser clips, incl. non-reflective PVC poster protectors, SK base black, fixed aluminium tube 80 mm, 1 hinge with locking screw underneath the back.
Total height: 62 cm.

Infoline 300 | 39300-xx/5

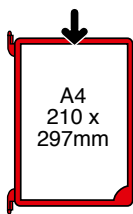

INFOLINE FRAME

Slim frame A4 with integrated browser clips and edge for easy grip. Suits all Infoline stands, in OEK standard colors.

A4 | 11406-xx
A3 (upon request) | 11306-xx

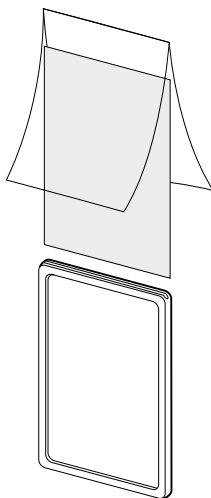

PVC POSTER PROTECTOR

Made of PVC 0,2 mm (A5 & A4), 0,3 mm (A3) folded on short side, non-reflective, clear.

A5 | 29100-A5/02
A4 | 29100-A4/02
A3 | 29100-A3/03

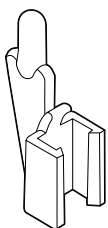

BROWSER CLIP

For swivel (A6 to A3) mounting of show-card frames series 100, to be used in Infoline models, clear.

21880-00



POSTERLINE STAND

Stable metallic stand, powder coated grey, with 10 frames A1 in OEK Standard colors with extra browser clips, incl. non-reflective PVC poster protectors.

Measurements approx. (W x H x D):
60 x 160 x 66 cm.

Delivered for self mounting.

39871-xx



POSTERLINE WALL

Metallic rear plates for wall fixing, powder coated grey, with 10 frames in OEK standard colors or anodized aluminium profile frames with extra browser clips, incl. non-reflective PVC poster protectors. Delivered for self mounting.

- | | | |
|-------------------------|--|----------|
| A1 (plastic frames) | | 39891-xx |
| A2 (plastic frames) | | 39892-xx |
| A1 (alu-profile frames) | | 39881-90 |
| A2 (alu-profile frames) | | 39882-90 |

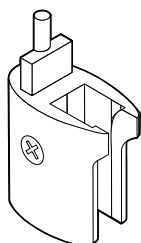

BROWSER CLIP WITH METAL-PIVOT

Very stable, screwed version with metal-pivot for frames series 200, to be used in Infoline and Posterline models, clear.

22890-00



CHECKOUT AND SALES MARKING

ADVERTISING ON SHOPPING TROLLEYS

BASKET DISPLAY – “ADVERTISING IN MOTION!”

Being suitable for almost all shopping trolleys, our basket display directs the attention of your customers straight to your advertisement. Take advantage of the possibility to present your advertising message on both sides.

The more information you give, the better you are able to sell!

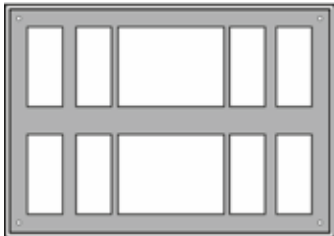

BASKET DISPLAY FOR SHOPPING TROLLEYS - A4 LANDSCAPE (PAIR)

To be attached by plastic clips or screws, with drain slots for rain water. For posters with up to 1,8 mm thickness. Colors: traffic red, black. Further colors available upon request.

with clip fixing | 18040-xx

with screw fixing | 18040-xx-M



PVC CUTTING

Suits grip and basket display, to protect your advertising and sales information, non-reflective PVC, thickness 0,2 mm, clear.

29000-A4/02



SHOWCARD FRAME 252 X 195 MM FOR SHOPPING TROLLEYS - LSE

Made of high-grade unbreakable plastics, specially designed for attachment onto shopping trolleys (outside or inside), fixing set to be ordered separately. Color: red.

11405-06



FIXING SET FOR SHOPPING TROLLEY FRAME

For attachment of standard showcard frames (series 100) onto shopping trolleys, 4-parts set, clear.

21432-00

PVC POSTER PROTECTOR 252 X 195 MM - LS

Suits showcard frame 252 x 195 mm for shopping trolleys, to protect your advertising and sales information, non-reflective PVC, folded long side, thickness 0,3 mm, clear.

29101-0005/03



GRIP DISPLAY – NEVER BEFORE YOU HAD SUCH A LONG-LASTING GRIP ON YOUR CUSTOMER!

Guide your customers through the colorful world of offers – single minded and efficiently: The grip display at the shopping trolley is the ideal means of communicating your adverts, special offers, general information such as “Where to find?” and all kind of brand promotion.

The perfect positioning guarantees that your message won't be missed – that's for sure!

GRIP DISPLAY A5 LANDSCAPE

2-parts anodized aluminium profile with 2 plastic end caps. Colors: available upon request. Suitable for shopping trolleys either with round or panoramic grip. External size: 220 x 163 mm. Transparent PVC-cover to be ordered separately (not included).

round grip | 18020-xx
panoramic grip | 18021-xx



SHOPPING BASKET

Made of plastic, 1 handle, 20 liters. Measurements: 300 x 230 x 430 mm, color: red. Further colors upon request. Logo print upon request.

18055-xx



KIOSK FLAGPOLE

Holder made of premium plastics, silver, with self-adhesive foam pad, in a 70° angle, slotted aluminium tube Ø 18 mm, length 800 mm. Set incl. hardware for wall fixing. Available upon request.

26695-91/9007



CHECKOUT AND SALES MARKING

STORAGE AND SALES CONTAINER



STORAGE AND SALES CONTAINER
Suitable for various applications, made of unbreakable, certificated plastics proofed for use and contact with food. Not stackable for usage but very well stackable for transportation. Measurements (W x H x D): 380 x 250 x 556 mm. Filling volume: 30 l, loading capacity: 25 kg, weight: 1,4 kg, color: traffic red.

80460-3020

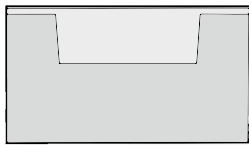

TAG HOLDER FOR CONTAINER
Suitable for inserts or price information labels in measurements 160 x 90 mm, to be put into the container's slit at the left hand side, made of bent PVC, clear.

29901-0008/05

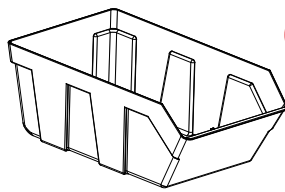

NEW

CONTAINER 11 L
Sales container 246 x 410 x 150 mm. Volume: approx. 11 l. Stackable in each other. (Not stackable over each other). Colors: transparent, red.

80463-xx

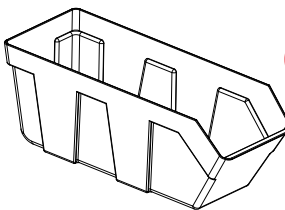

NEW

CONTAINER 7 L
Sales container 146 x 410 x 150 mm. Volume: approx. 7 l. Stackable in each other. (Not stackable over each other). Colors: transparent, red.

80462-xx

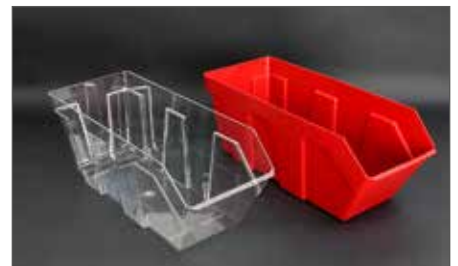



SUSPENSION SYSTEMS

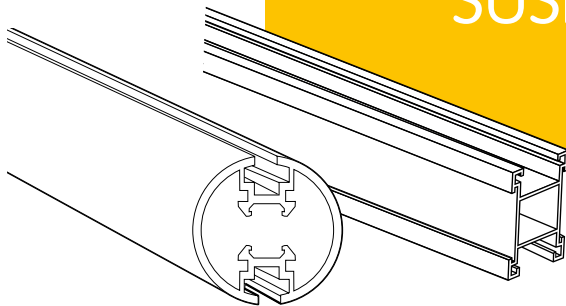

SUSPENSION SYSTEMS

POSTER RAILS

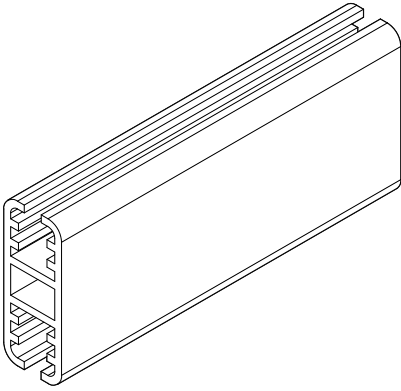

POSTER RAIL AMBIENTE

Alu-anodized aluminium profile (42 x 17 mm), can be easily bended e.g. for use as full or semi circle or similar. As full circle available in radiuses:

R 800 mm | 50920-91/R0800
R 1250 mm | 50920-91/R1250

Poster rail Ambiente:
1000 mm | 50920-91/1000

Other lengths upon request.

Please order cable suspensions separately.

Of the accessories series 500 there can be used: Rail ring to be directly turned into poster rails Art.-No. 25730-xx (only colored), Hanging ring Art.-No. 25710-03 (grey) and suspension ring Art.-No. 25700-xx (colored and clear).

We are happy to create your individual offer.

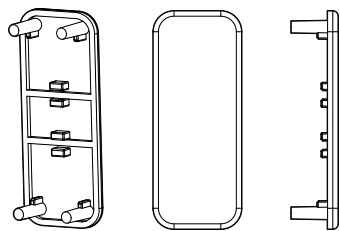
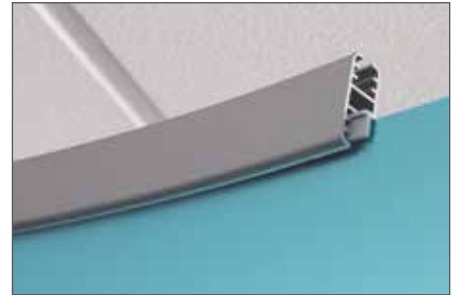

END CAP RAIL AMBIENTE

Suits poster rail Ambiente for a neat rail end, grey.

25686-03



FOIL GRIP

Clip for poster rail Ambiente with profile for a secure hold of foils with material thickness of 0,4 - 0,8 mm.

Foil Grip SG, grey | 25780-03
Foil Grip XT, black | 25785-10



CABLE SUSPENSION WITH PLATE FOR AMBIENTE RING

Suitable to suspend our poster rail Ambiente as ring. Adjustable wire cable Ø 1,5 mm with slipknot, zined plate for a quick and easy, sideways insert into the rail profile. Further lengths and cable suspensions for poster rail Ambiente (straight) available upon request.

2000 mm | 25699-00/2000



POSTER RAILS

Energize your advertising with our selection of OEK poster rails! Various types of suspension rails made of plastic and aluminium with an extensive set of accessories allow for the perfect placement of showcard frames, price displays, profile frames and much more, regardless of the application.

Remark:

For fixing the aluminium poster rails you can also use the following elements:

- Poster rail I: → accessories showcard frames (series 100)
- Poster rails II and III: → accessories showcard frames (series 500)

Colors:

The aluminium poster rails are also available in special colors (coated similar to RAL colors). Please contact us for more details or a quote.

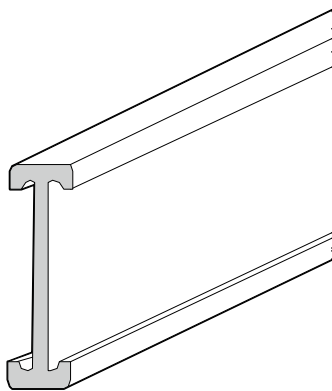

POSTER RAIL I

Anodized aluminium, profile 45 x 10 mm, with insert for promotional strips with 39 mm height. Standard lengths 200 and 300 cm. Special colors are available upon request.

For suitable elements to suspend rail and frames, please see chapter accessories showcard frames (series 100). Available upon request.

15401-90/xxxx

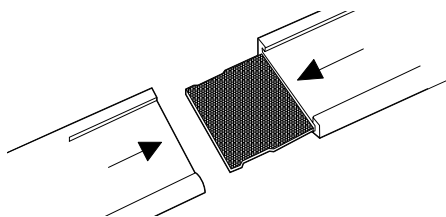

CONNECTOR FOR POSTER RAIL I

To connect single poster rails I, zinc coated metal.

25601-00

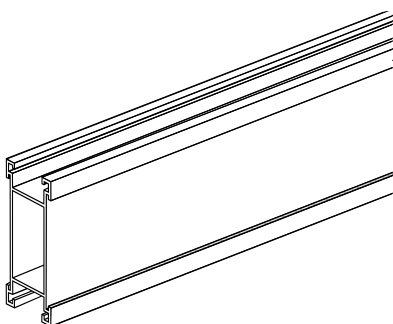

POSTER RAIL II

Anodized aluminium, profile 20 x 40 mm, insert for promotional strips with 32 mm height, standard lengths 100, 200 and 300 cm. Special colors are available upon request.

15402-90/xxxx



SUSPENSION SYSTEMS

POSTER RAILS

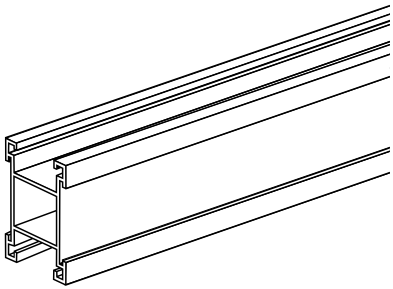

POSTER RAIL III

Anodized aluminium, profile 20 x 20 mm, standard lengths 100, 200 and 300 cm. Special colors are available upon request.

15403-90/xxxx

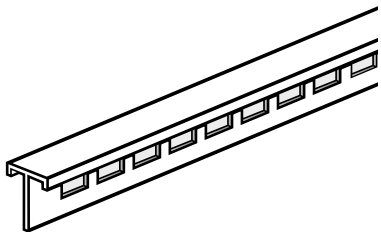

GRIP STRIP

For direct insert into poster rails II and III, allows for a quick and easy change of your information displays. Made of clear plastics, standard lengths 100 and 200 cm. PU: 10 pcs.

22570-xxxx



HANGER WITH BENDED SCREW HOOK

Hanger for poster rail II - consisting of zinc plated steel plate (50 x 14 x 3 mm with thread M4) and bended screw hook (zinc plated).

6-00379-0004

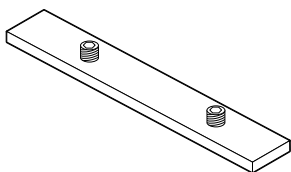

CONNECTOR

To connect two single rails, suits poster rails II and III, zinc coated metal with 2 stud screws.

With poster rail II we recommend to use two connectors.

25610-00

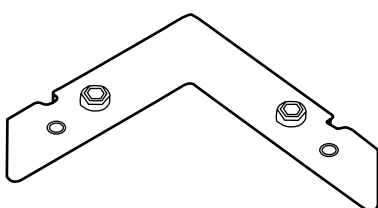

CORNER CONNECTOR 90°

Suits poster rails II and III, to connect two rails with mitred corners, zinc coated metal with 4 stud screws.

With poster rail II we recommend to use two connectors.

25620-00



T-CONNECTOR FOR ALU POSTER RAIL II AND III

For a stable and invisible T-connection of poster rails II and III, zinc coated metal. Set consisting of 2 T-connectors, 4 standard connectors and 8 screws.

25625-00

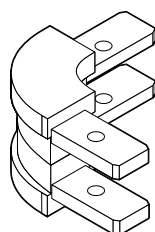

CORNER CONNECTOR, 2-PARTS

Suits poster rail II, to connect two rails without mitred corners in a 90° angle, 2-parts with screws, grey.

25650-03

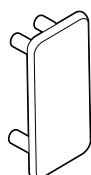

END CAP II

Suits poster rail II, for a neat closing, grey.

25670-03

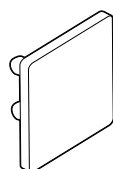

END CAP III

Suits poster rail III, for a neat closing, grey.

25680-03

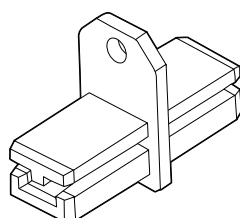

CONNECTOR (RAIL III) WITH RING

Suits poster rail III, to connect two rails while suspending them by the integrated ring, grey.

25630-03

SUSPENSION SYSTEMS

ACCESSORIES FOR POSTER RAILS

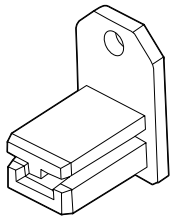

END CAP (RAIL III) WITH RING

Suits poster rail III, for a neat closing and suspension by the integrated ring, grey.

25735-03

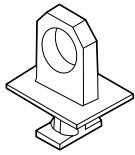

RAIL RING

To be directly turned into poster rails II and III for both - suspending the rail itself as well as the frames, grey.

25730-03



SUSPENSION RING

To suspend poster rails II and III, to be turned into top groove, clear.

25700-00

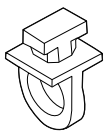

HANGING RING

To be turned into rails II and III to suspend frames, clear.

25710-00



CABLE SUSPENSION

Suitable to suspend our alu rails II, III, alu clamp rail 40 and priceboards. Adjustable wire cable Ø 1,2 mm with hooks, plate for a quick and easy, sideways insert into the rail profile. Further lengths are available upon request.

1000 mm		25696-00/1000
2000 mm		25696-00/2000
3000 mm		25696-00/3000



SUSPENSION SYSTEMS

ACCESSORIES FOR POSTER RAILS

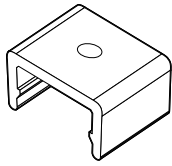

CEILING FASTENER

To fix poster rails II, III or profile frames series 500 directly to ceilings, clear.

25181-00

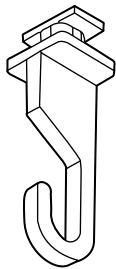
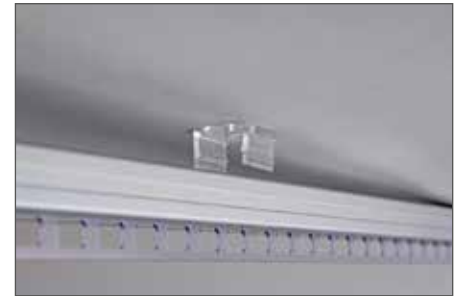

SUSPENSION HOOK

Suits poster rails II and III, to be turned directly into the rail profile, for suspension of frames and displays, clear.

25750-00

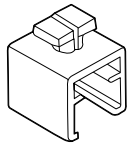

FRAME CLIP

Suits poster rails II and III, to be turned directly into the rail profile to suspend frames A6 - A3 (series 100) with lateral poster insert, clear.

25740-00

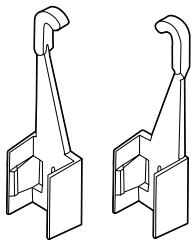

HANGING HOOK L = 54 MM (PAIR)

Suits poster rails II and III, to be hung directly into the rail profile to suspend frames A6 - A3 (series 100) with top poster insert, clear. Not suitable for Laminate- or DEKO-frames.

25760-00

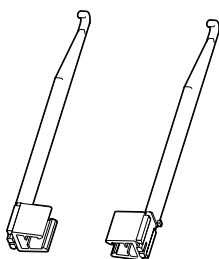

HANGING HOOK LONG L = 137 MM (PAIR)

Especially long hooks to suspend frames with top signs or headers with up to 10 cm, to be hung directly into poster rails II and III, clear.

25770-00



SUSPENSION SYSTEMS

POSTER RAIL ROUND TUBE

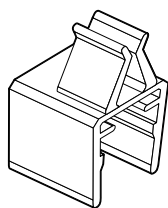

PROMOTION CARD CLIP

To fix promotion signs to poster rails II and III in a standing or hanging position, insert thickness 0,3 - 2,0 mm, clear.

25920-00

POSTER RAIL ROUND TUBE

Aluminium anodized tube Ø 20 mm, standard length 200 cm.

aluminium anodized | 57810-91/xxxx

white (on request) | 57810-01/xxxx

black (on request) | 57810-10/xxxx



METAL TUBE CONNECTOR

For a stable connection of round tubes Ø 20 mm, aluminium.

25175-00

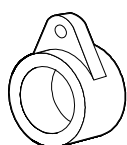

SUSPENSION RING

To suspend poster rail round tube, grey.

25160-03

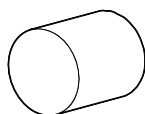

END CAP

Suits poster rail round tube, for a neat closing, grey.

25170-03

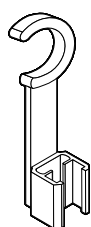
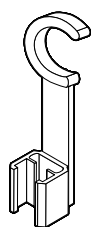
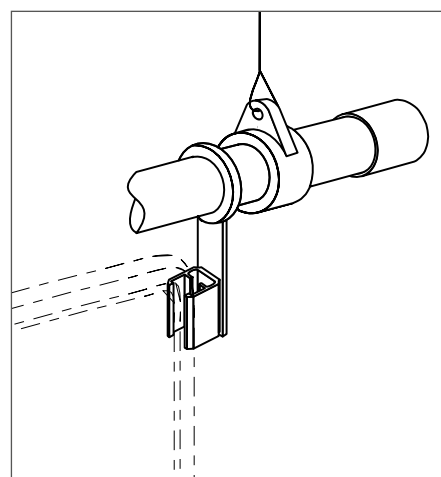

TUBE CLIP, SWIVEL TYPE (PAIR)

To suspend frames from round rails, tubes, etc., clip Ø 22 mm, clear.

series 100 | 21610-00

series 200 | 22610-00

series 500 | 25521-00



SUSPENSION SYSTEMS

SYSTEM TUBE QP WITH ACCESSORIES

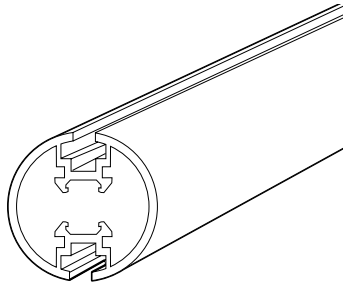

SYSTEM TUBE QUICKPRICE QP
Anodized aluminium, tube Ø 25 mm,
length 200 cm. Special colors are available
upon request.

15410-90/2000

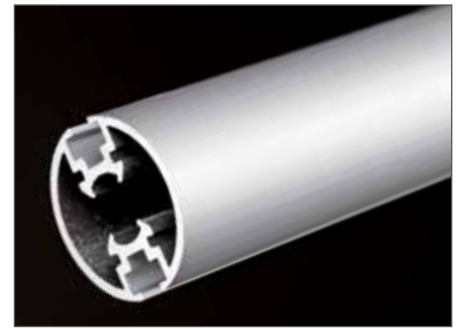

GRIP STRIP FOR SYSTEM TUBE QP
For a quick and easy suspension and
change of frames, poster pockets, etc.,
made of clear plastics, length 200 cm.

22560-00/2000



END CAP QP
Suits system tube qP for a neat closing,
grey.

25685-03

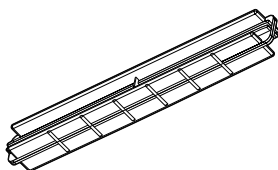

TUBE CONNECTOR QP
For a quick connection of single system
tubes qP, length 160 mm, made of premium
plastics, grey.

25603-03

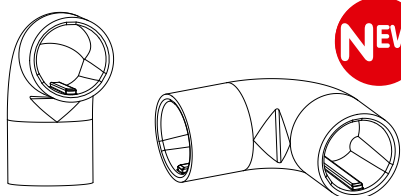

NEW

CORNER CONNECTOR QP 90°
To connect single system tubes qP around
the corner, grey.

vertical | 25602-03
horizontal | 25602-03/W



SUSPENSION SYSTEMS

SYSTEM TUBE QP WITH ACCESSORIES

TUBE CONNECTOR QP WITH RING

To connect single system tubes qP, length 60 mm, made of zinc coated metal with 2 fixing screws and integrated ring.

25606-00



CABLE SUSPENSION FOR QP SYSTEM TUBE

Suitable to suspend our system tube qP. Adjustable wire cable Ø 1,2 mm with hooks, plate for a quick and easy, sideways insert into the rail profile. Further lengths are available upon request.

1000 mm		25697-00/1000
2000 mm		25697-00/2000
3000 mm		25697-00/3000



SUSPENSION HOOK QP

To suspend frames, poster pockets, etc., to be turned sideways into qP tube profile, clear.

25751-00



SUSPENSION RING QP

To suspend frames, poster pockets, etc. using C- or S-hooks, to be turned into qP tube profile from sideways, clear.

21362-00

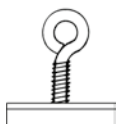

SUSPENSION RING (ALU) FOR SYSTEM TUBE QP

Stable suspension ring Ø 5 mm made of aluminium T-profile, to be inserted into the qP tube profile for a secure fixing.

21363-00

SUSPENSION SYSTEMS

PRICEBOARD

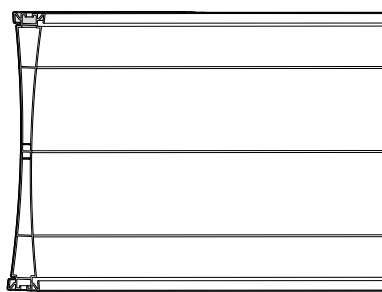

PRICEBOARD

Extruded, concave shaped profile made of premium plastics, for double-sided insert of posters A5 or A4. Colors and lengths are available upon request.

A5		15420-xx/xxxx
A4		15421-xx/xxxx

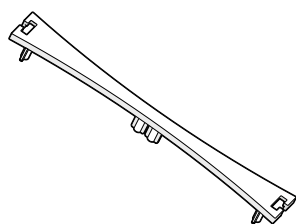

END CAP FOR PRICEBOARD

For a neat closing. Colors upon request.

A5		25690-xx
A4		25691-xx

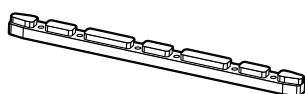

CONNECTOR FOR PRICEBOARD

To connect single priceboards, we recommend to use 2 connectors (top and bottom), made of plastics with screws. Colors upon request.

25692-xx



SUSPENSION RING FOR PRICEBOARD

To be turned into the priceboard profile, for suspension to be used together with C-hooks or knot chain. Also suitable to mount aluminium poster rail II and III. Colors upon request.

25694-xx



SUSPENSION SYSTEMS

CLAMP- AND SNAP RAILS

CLAMP- AND SNAP RAILS

Would you like to hang up big-size posters? No problem when using OEK rails. The clamp and snap mechanism of the different rails as well as various types of profiles and materials provide quick and easy handling along with an elegant design.

Remark:

You will find the suitable fixing elements on the following pages under the heading → **mounting accessories**.

For the alu clamp rail 40 all the → **accessories profile frames (series 500)** can be used.



POSTER CLAMP RAIL 15

Clear plastics, profile 15 mm, to insert papers from sideways, upper rail with 2 punched rings for suspension, 2-parts set. Standard lengths 500, 600, 790 and 1200 mm. PU: 10 sets.

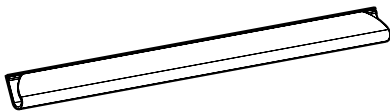

length 500 mm		15440-00/500
length 600 mm		15440-00/600
length 790 mm		15440-00/790
length 1200 mm		15440-00/1200

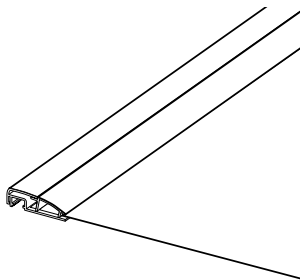

POSTER CLAMP RAIL 18

White plastics, profile 18 mm with snap mechanism, for papers up to 1 mm thickness, upper rail with 2 suspension rings, no adhesive tape, 2-parts set. PU: 10 sets.

Also available in further colors or with rear adhesive tape upon request.

special lengths		15452-01/xxxx
length 600 mm		15452-01/0600
length 980 mm		15452-01/0980

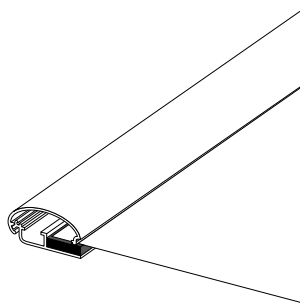

ALU SNAP RAIL 25

Anodized aluminium profile 25 mm with snap mechanism to clamp posters with material up to 3 mm thickness. Integrated rubber inlay ensures a secure clamp. Upper rail with 2 suspension rings, both rails with grey end caps, 2-parts set. Standard lengths.

length 600 mm		71-50000-91/0600
length 850 mm		71-50000-91/0850
length 1000 mm		71-50000-91/1000



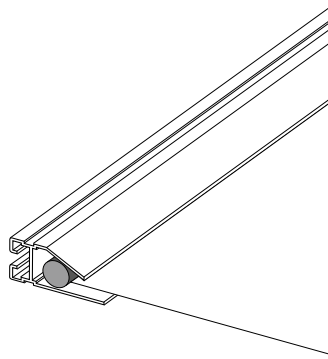

ALU-CLAMP RAIL 40 WITHOUT ADHESIVE

Anodized aluminium, profile 40 mm, to clamp papers, cartons, foils, etc. with up to 3 mm thickness. Standard lengths 500 and 1000 mm. Special lengths up to 2500 mm are available as from 10 sets min. upon request.

length 500 mm		50100-91/0500
length 1000 mm		50100-91/1000

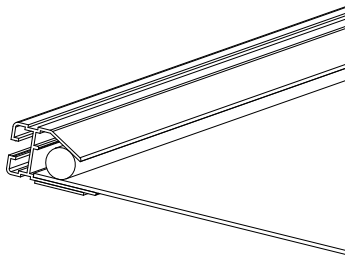

ALU-CLAMP RAIL 40 WITH ADHESIVE

Anodized aluminium, profile 40 mm, to clamp papers, cartons, foils, etc. with up to 3 mm thickness. With double foam adhesive tape. Standard lengths 500 and 1000 mm. Special lengths up to 2500 mm are available as from 10 sets min. upon request.

length 500 mm		50110-91/0500
length 1000 mm		50110-91/1000



MOUNTING ACCESSORIES

For mounting and suspending priceboards, aluminium poster rails, clamp- and snap rails etc. we offer a large and well-assorted selection of different accessories. If you have any specific demands on the fixing system, we will be happy to find an individual solution for you. Just contact us!

METAL CEILING CLIP

Clip for special Odenwald ceiling grid, to suspend poster rails, priceboards, etc., force up to 18 kgs, coated metal white. PU: 100 pcs.

20660-01



CADDY CLIP

Clip for special Odenwald ceiling grid, to suspend poster rails, priceboards, etc., force up to 18 kgs, zinc metal. PU: 100 pcs.

20679-00

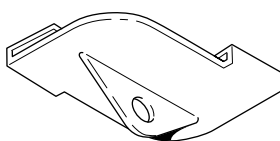

PLASTIC CEILING CLIP

Clip for special Odenwald ceiling grid, to suspend poster rails, priceboards, etc., force up to 4 kgs, plastics white. PU: 100 pcs.

20665-01



SUSPENSION SYSTEMS

MOUNTING ACCESSORIES

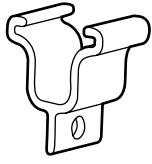

CEILING CLAMP

Clamp with ring \varnothing 4 mm for special Odenwald ceiling grid, to suspend poster rails, frames or displays with universal hooks, chains, cable suspensions etc., white, force up to approx. 3 kgs.
PU: 100 pcs.

20678-01

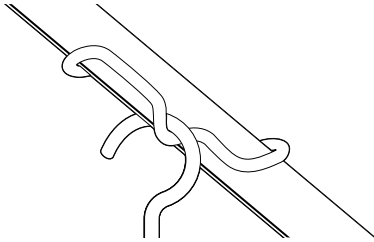

WIRE CEILING CLIP 20

Clip for special Odenwald ceiling grid, to suspend poster rails, frames, poster pockets or similar with hooks and chains.
PU: 100 pcs.

20674-00



CEILING RING \varnothing 40 MM

With double foam adhesive tape, white.

20671-01

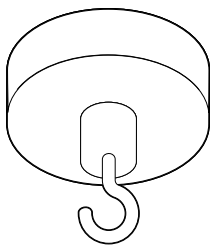

MAGNET FOR CEILING

To suspend poster rails, poster pockets or similar with hooks, chains, etc., magnetic force up to approx. 20 kgs (\varnothing 50 mm) resp. 8 kgs (\varnothing 32 mm), white.

\varnothing 32 mm		20637-01
\varnothing 50 mm		20635-01



UNIVERSAL HOOK

To hang poster rails, priceboards, poster pockets, etc. with knot chains, available in standard lengths 100, 150, 200, 250, 300, 400, 500 and 750 mm.
PU: 50 pcs.

length 100 mm		24214-00/0100
length 150 mm		24214-00/0150
length 200 mm		24214-00/0200
length 250 mm		24214-00/0250
length 300 mm		24214-00/0300
length 400 mm		24214-00/0400
length 500 mm		24214-00/0500
length 750 mm		24214-00/0750



S-HOOK, 22 MM

To suspend poster rails, poster pockets, etc., with knot- or decochains, length 22 mm. PU: 100 pcs.

20685-00

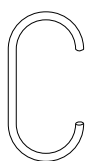

C-HOOK

To suspend poster rails, poster pockets, etc. with knot- or decochains, PU: 100 pcs.

39 mm | 20683-00
60 mm | 20684-00



PLASTIC SUSPENSION HOOK FOR TUBES Ø 44 MM

Solid hook made of molded plastic to be riveted to alu snap rail or directly on to PVC pockets or covers. Suitable for up to 44 mm tube diameter. Easy hanging and change of posters, even from big heights using a telescopic rod (available upon request). Color: similar to RAL 9007 (grey aluminium).

84-15508-9007



METAL HOOKS FOR TUBES

Suitable for tubes Ø 35 mm, to suspend frames, poster pockets, etc., made of zinc coated metal. PU: 50 pcs.

25752-00



KNOT CHAIN K16

To hang poster rails, poster pockets or similar. PU: roll with 30 m.

20690-00



SUSPENSION SYSTEMS

MARKING FOR BEVERAGES

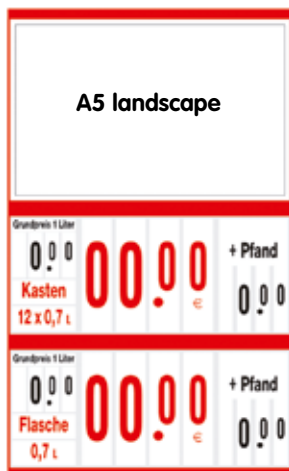

PRICE CASSETTE FOR BEVERAGES QP 2236
 Price cassette with plastic housing colored and 3 single cassette boxes to be opened individually, clear.

Top cassette for posters or wording A5 landscape. Lower cassette with folded number strips red/black and basic price information.
 Size: 221 x 361 mm.
 Colors white and red.
 (Other colors available upon request).

14362-xx



DOUBLE CONNECTOR
 To connect and suspend 2 single qP price cassettes or qP displays, clear.
 PU: 20 pcs.
 Available upon request.

24860-00



SUSPENSION Ø 12 MM
 With hook for tubes Ø 12 mm, clear.
 PU: 20 pcs.
 Available upon request.

24800-00

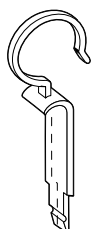

SUSPENSION HOOK Ø 26 MM
 With hook for tubes Ø 26 mm, clear.
 PU: 20 pcs.
 Available upon request.

24810-00

SUSPENSION SYSTEMS
MARKING FOR BEVERAGES



SUSPENSION RING
Suspension with ring, clear. PU: 20 pcs.
Available upon request.

24820-00

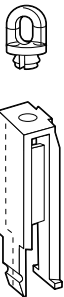

SUSPENSION
To suspend two single qP price cassettes for beverages (back to back), clear.
PU: 20 pcs.
Available upon request.

24830-00

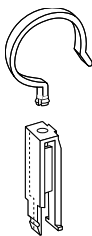

SUSPENSION (DOUBLE) WITH HOOK
To suspend two qP cassettes for beverages (back to back), clear. PU: 20 pcs.
Available upon request.

24840-00



SINGLE PLASTIC CASSETTE FOR SPIRAL BOUND NUMBER BLOCKS
Single plastic cassettes made of white polystyrene to create customized price displays. Based on PS slates, designed and printed individually, requested cassette combinations are fixed to the slate by US welding, PVC pockets or covers can be glued to the slate for additional promotional information. Single- or double sided designs.

single cassette
40 x 80 mm | 24630-01
76 x 80 mm | 24620-01
76 x 181 mm | 24610-01



SUSPENSION SYSTEMS

MARKING FOR BEVERAGES



DIVERSE PRICE DISPLAYS FOR BEVERAGES

Price displays made of PS, different sizes and colors, upper section for insert of advertising posters A5 landscape, price marking (one-sided) with small spiral bound numbers or text inlays.

Available upon request.



POSTER BOARD 25 X 51 CM

Suitable for individual price marking with PC prints. To insert posters in upper part with size A5 landscape, lower section with poster pocket for inlays A4 portrait. Made of white PS, with red frame, single-sided. PU: 10 pcs.

Available upon request

14541-06

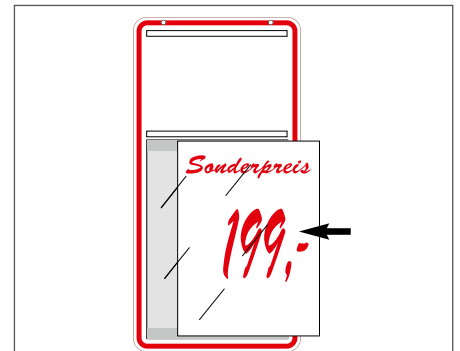

POSTER POCKET WITH CROSS BAR

To insert posters A5 landscape and A4 portrait, made of non-reflective PVC 0,4 mm, clear for fixing with special clamp hooks Ø 4 mm.

29607-A4A5/04



SUSPENSION COVER

For a quick and stable suspension of posters, with holes Ø 1 mm to be used with clamp hook Ø 4 mm, made of non-reflective, bent hard PVC 1 mm, clear.

A4 portrait | 29800-A4/10

A4 landscape | 29801-A4/10



SUSPENSION SYSTEMS

MARKING FOR BEVERAGES

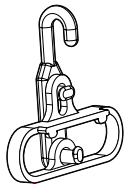

CLAMP HOOK Ø 4 MM

Fixed fitting, to be tightly clipped onto punched displays for beverages, suspension cover, etc. with up to 1 mm thickness, white. Suiting only for precise hole drillings of Ø 4 mm and a distance of 7 mm (distance between display edge and outer line of hole).

20680-26

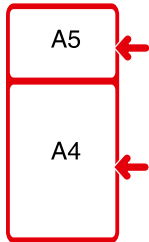

SHOWCARD FRAME WITH CROSS BAR - LSE

Showcard frame with cross bar for posters sizes A4 portrait and A5 landscape, long side poster entry, to be used with accessories (series 100). Colors: white, red, green.

11445-xx



CARDBOARD CLAMP 3

To attach onto cartons, boxes, boards etc. with material of up to max. 20 mm thickness. Top part for insert of promotion signs with up to 3 mm thickness, 2-parts, clear. Also functional for bigger carton signs. We recommend to use 2 clamps.

17040-00



CARDBOARD CLAMP WITH METAL SPRING

To attach onto crates, wooden boxes and other packings. Suitable for material thickness 0,5 up to max. 3 mm. Height 140 mm, width 60 mm. Width of spring: approx. 15 mm. Color: clear.

17090-00

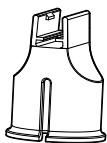

BOTTLE HOLDER SERIES 100

Fitting onto all PET bottles (1,5 L - 1,0 L - 0,5 L), holding showcard frames (series 100), clear.

20025-00

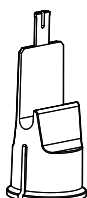

KLICK BOTTLE HOLDER

Fitting onto all PET bottles (1,5 L - 1,0 L - 0,5 L), with rear Klick adaptor to hold qP price cassettes, shelf barkers, etc., colors: clear, grey.

20026-00





ACRYLIC DISPLAYS & PVC-PRODUCTS

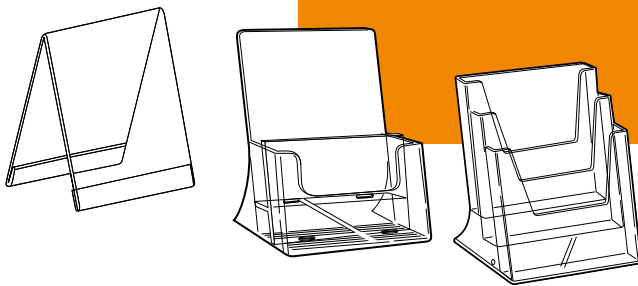

ACRYLIC SUPPORTS



ACRYLIC BOXES



PVC-PRICE TAG POCKETS



ACRYLIC DISPLAYS & PVC-PRODUCTS

ACRYLIC DISPLAYS

ACRYLIC DISPLAYS

Don't miss the current trend when it comes to choosing the right design and material for price labeling and sales displays: Acrylics ensures a "crystal clear presentation" of your advertising message. The print is completely covered and protected – without distracting lines or colours.

Remark:

If you have any particular demands on the shape or size of the display, we will be glad to provide you with a customized model. Just send us your inquiry.

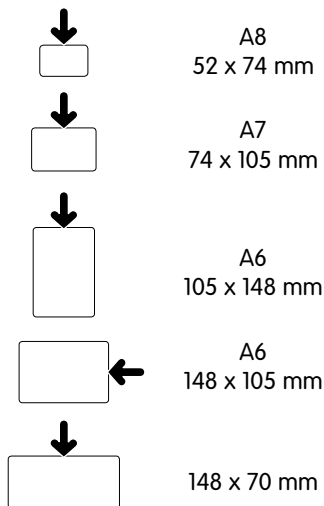

KLICK ACRYLIC BARKER

The print is completely covered and protected - without distracting lines or colors. With rear Klick adaptor to take any of the Klick fixing accessories (see chapter shelf promotion), clear.

A8		13580-25
A7		13570-25
A6 portrait		13561-25
A6 landscape		13560-25
148 x 70 mm		13504-25

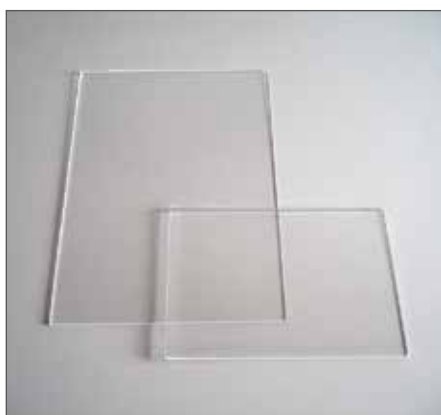

ACRYLIC COVER

For ONDA and holder 150 resp. 210, bent acrylic with 2 mm thickness, clear, total thickness 4 mm (bent: 2 x 2 mm).

Other sizes are available upon request.

A6 portrait		27100-A6/20
A5 portrait		27100-A5/20
A5 landscape		27101-A5/20
A4 portrait		27100-A4/20
A4 landscape		27101-A4/20



ACRYLIC SHOWCARD STAND WITH U-FRAME

U-frame A4 landscape with acrylic cover, fixed chromium tube 310 mm, rectangular K base. Colors: white, grey, red, silver.

35051-xx



ACRYLIC SHOWCARD STAND "ONDA"

Acrylic cover A4 portrait or A5 landscape with plastic ONDA holder, fixed chromium tube 310 mm, pyramid base Ø 160 mm. Colors: grey, red, ultramarine blue, silver.

A5 landscape		35062-xx
A4		35061-xx



ACRYLIC SHOWCARD STAND BD

BD base Ø 160 mm silver-grey, adjustable chromium tube 320 - 620 mm with lever clamp, holder 210 with acrylic cover A4 portrait.

33342-03/00/-620



ACRYLIC DISPLAYS & PVC-PRODUCTS

ACRYLIC SUPPORTS

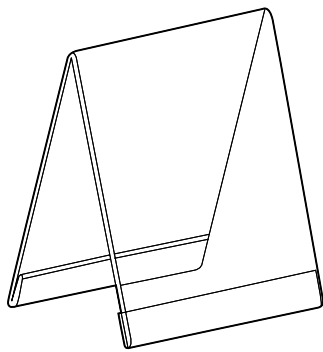

ACRYLIC STAND "A"

Premium acrylics 2 mm thickness in A-shape, 3-fold bent available portrait or landscape, clear. For poster inserts with max. 150 g/sqm.

A7		27500-A7/20
A7 landscape		27501-A7/20
A6		27500-A6/20
A6 landscape		27501-A6/20
approx. 210 x 105 mm		27501-0005/20

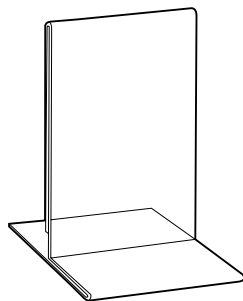

ACRYLIC STAND "T"

Premium acrylics 2 mm thickness in T-shape, 3-fold bent available portrait or landscape, clear. For 2 poster inserts with max. 150 g/sqm each.

A6		27400-A6/20
A5		27400-A5/20
A4		27400-A4/20
approx. 210 x 105 mm		27400-0005/20

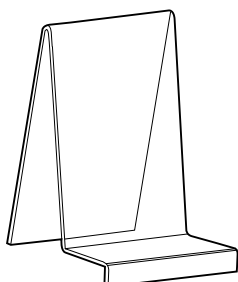

BOOK-REST

Premium acrylics of 2 mm thickness in A-shape with 1 presentation stairs (25 mm depth) for books, perfumes, etc., 3-fold bent. Size: 100 x 110 mm portrait, clear.

27600-0001/30





MENU HOLDER BASE "SWING-WING"
Elegant menu holder base, made of aluminium clamp profile, suitable for materials of 1 - 4 mm with clear acrylic cover. The curved aluminium profile can be printed individually with logo, slogans, etc. upon request.

A4 portrait		18204-00
A5 portrait		18205-00
approx. 210 x 105 mm		18209-00



ACRYLIC STAND "STEEL-ARC"
Arch holder 180 x 70 mm made of brushed stainless steel with insert slit 4,5 mm wide and max. insert depth of 14 mm, incl. bent acrylic cover portrait.

A5		27800-A5/20
A4		27800-A4/20

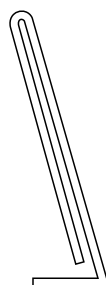

ACRYLIC L-SUPPORT
Premium acrylics of 2 mm thickness in inclined L-shape, 2-fold bent, available portrait or landscape, clear.

A7		27300-A7/20
A7 landscape		27301-A7/20
A6		27300-A6/20
A6 landscape		27301-A6/20
A5		27300-A5/20
A5 landscape		27301-A5/20
A4		27300-A4/20
A4 landscape		27301-A4/20
A3 (3 mm)		27300-A3/30
A3 (3 mm) landscape		27301-A3/30



L-SUPPORT CHALKBOARD
L-support made of PS (2,0 mm), slate coated. Look: mat black, chalkboard style. Sizes: A4 portrait, A5 portrait, A6 portrait.

A4 portrait		30302-A4/20
A5 portrait		30302-A5/20
A6 portrait		30302-A6/20



Please note: These chalk boards are not heat-resistant. An exposure to direct sun light for example may lead to a deformation of the boards.

ACRYLIC DISPLAYS & PVC-PRODUCTS

ACRYLIC SUPPORTS

ACRYLIC HOLDER A4 WITH ALU SNAP RAIL

Premium acrylics of 2 mm thickness in inclined L-shape, portrait, clear with elegant alu snap rail 25, alu-anodized, with grey end caps, length: 210 mm.

27308-A4/20



LEAFLET DISPENSER T

Leaflet dispenser T for desks and counters.
Depth: 31 mm, clear

A4 portrait | 32014-00/31

A5 portrait | 32015-00/31

approx. 210 x 105 mm | 32019-00/31

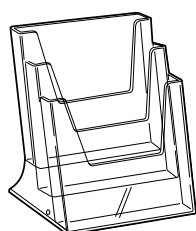

LEAFLET BOX "TRIPLE"

Leaflet box for inclined desk presentation of several brochures behind each other.
Depth: 105 mm total, clear.

A4 portrait | 32034-00/105

A5 portrait | 32035-00/105

approx. 210 x 105 mm | 32039-00/105



BOX FOR BUSINESS CARDS "DESK"
Box for business cards, to be placed on desks or counters, size 95 x 54 x 19 mm (landscape), color: black, clear.

32013-xx/13



BOX FOR BUSINESS CARDS "WALL"
Box for business cards for wall fixing.
Size: 95 x 54 x 19 mm (landscape), clear.

32113-00/19

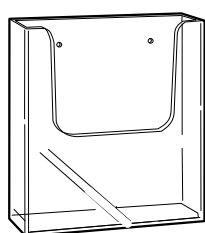

LEAFLET BOX W

Leaflet dispenser box with 2 holes for wall fixing. Depth: 35 mm, clear.

A4 portrait		32114-00/35
A5 portrait		32115-00/35
approx. 210 x 105 mm		32119-00/35



CLIPBOARD

Trendy blotting pad for A4 paper (other sizes possible) made of LiSa (light collecting material) with alu snap rail and transparent holder for pens.
Available upon request.



ACRYLIC DISPLAYS & PVC-PRODUCTS

PVC-PRICE TAG POCKETS

POSTER POCKET

Poster pocket made of bent, non-reflective PVC with rivet metallic rings, nickel plated for suspension. PU: 10 pcs.

A4 (0,3 mm)		29600-A4/03
A3 (0,3 mm)		29600-A3/03
A2 (0,4 mm)		29600-A2/04
A1 (0,4 mm)		29600-A1/04



HARD PVC POSTER POCKET A4 LANDSCAPE

Poster bag A4 made of double bent, glossy hard PVC 1 mm, C-shaped with rivet metallic hooks for a quick suspension, clear.

29229-A4/10



SUSPENSION COVER

For a stiff and therefore very comfortable and easy suspension along with fitting clamp hooks Ø 4 mm, made of bent, non-reflective hard PVC 1 mm, clear.

A4 portrait		29800-A4/10
A4 landscape		29801-A4/10

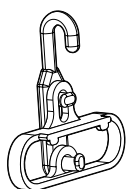

CLAMP HOOK Ø 4 MM

Fixed fitting, to be tightly clipped onto punched displays for beverages, suspension cover, etc. with up to 1 mm thickness, white. Suiting only for precise hole drillings of Ø 4 mm and a distance of 7 mm (distance between display edge and outer line of hole).

20680-26



PVC COVER MAGNETIC "EASY CHANGE", A4 PORTRAIT

For quick and easy change of posters, fixed by glued magnetic tapes (pair), 11 mm foam adhesives on rear. Size of printing on top 21 mm, bottom 11 mm. Material thickness: 0,3 mm. Colors: white, red. Individual logo print or other colors and sizes are available upon request.

white		29006-A4/03/01
red		29006-A4/03/06



WINDOW SHOWCARD FRAME

For quick and professional presentation of posters in shop-windows with ambitious frame design. The plastic frame is fixed with adhesive tape on lower side and can be opened on 3 sides over magnetic tape to change posters.

For poster size A1 and A2 available with passepartout for next smaller size. Other sizes available upon request.

Material: PETG / PVC
Size A1: 841 x 594 mm (H x W)

Standard colors: silver and black shading. Other colors available upon request.

Available upon request.



Without Passepartout



With Passepartout



PRICE TAG POCKET

Welded price tag pocket made of glossy soft PVC 0,2 mm, with 1 center hole (A4 with 2 holes) above insert, portrait, clear. PU: 100 pcs.

A4		29850-A4/02
A5		29850-A5/02
A6		29850-A6/02
A7		29850-A7/02
A8		29850-A8/02

FASTENER FOR PRICE TAG POCKETS

For a secure and fast fixing of above price tag pockets, e.g. onto furniture, tools, textiles, etc., white. PU: 1.000 pcs.

24900-00





WOODLINE



WOODLINE

For a "natural and genuine" presentation – The showcard frame system Woodline made of massive and untreated beechwood offers a variety of applications.

No matter whether you use it as single frame or complete showcard stand – this pure natural product will always leave a special impression.

Remark:

Frames in special sizes or in special coated colors are available subject to a minimum order quantity of 50 pieces.

Being a natural product, the frames may vary in coloring and grain.

You will find the suitable fixing elements for the Woodline showcard frames under the heading → **accessories (series 500)**.



WOODLINE FRAME

Massive wooden frame made of natural beech (-00) or thermo ash (-TE). Sawed on mitred. Poster entry short side. For posters and inserts with max. 4 mm thickness. Backside with 4 holes for hanging upright and landscape. Please note that accessories series 500 are not compatible to this product.

A5 (beech nature)		15380-00/A5
A5 (thermo ash)		15380-TE/A5
A4 (beech nature)		15380-00/A4
A4 (thermo ash)		15380-TE/A4
A3 (beech nature)		15380-00/A3
A3 (thermo ash)		15380-TE/A3



SHOWCARD FRAMES WOODLINE

Massive wooden frame made of natural beech. Poster insert on short frame side. For posters and inserts with max. 4 mm thickness. Also available with internal thread, threaded bolt M10, on short side for a direct tube connection. Special sizes, colors or frames with poster entry long side available upon request.

A5		15350-00
A5 - M10		15351-00
A4		15340-00
A4 - M10		15341-00
A3		15330-00
A3 - M10		15332-00
A2		15320-00
A2 - M10		15321-00
A1		15310-00
50 x 70 cm		15370-00



WOODLINE

COMPONENTS AND ACCESSORIES



WOODEN BASE FOR WOODLINE FRAMES

Wooden stand made of natural beech or thermo ash for Woodline frames.

Natural beech A3		20495-00/A3
Thermo ash A3		20495-TE/A3
Natural beech A4		20495-00/A4
Thermo ash A4		20495-TE/A4
Natural beech A5		20495-00/A5
Thermo ash A5		20495-TE/A5



WOODEN BASE (PAIR)

For an upright presentation of Woodline frames, made of massive natural beech, incl. screws for fixing.

Small		25882-11
Large		25880-11



Please note: These chalk boards are not heat-resistant. An exposure to direct sun light for example may lead to a deformation of the boards. For heat-resistant chalk boards see page 194.

CHALK BOARD

Made of polystyrene, both sides slate coated, for showcard frames of same size, rounded edges, black. Material thickness: A5 - A3: 0,95 mm; A2-A1 and 50 x 70 cm: 1,5 mm.

A5		30012-A5/095
A4		30012-A4/095
A3		30012-A3/095
A2		30012-A2/15
A1		30012-A1/15
50 x 70 cm		30012-B2/15



CHALK BOARD MARKER POSTERMAN (WATER SOLUBLE)

To write on chalk boards, color: white. PU: 8 pcs.

5 mm		24281-01
15 mm		24280-01



CHALK BOARD MARKER POSTERMAN (WATER RESISTANT)

Color: white. PU: 8 pcs.

5 mm		24282-01
15 mm		24284-01

POSTERMAN CLEANER

Cleaning solution to wipe out the water resistant chalk board marker Posterman. PU: 1 can (1l).

24283-00



BD SHOWCARD STAND WOODLINE

BD base Ø 255 mm black, adjustable alu-anodized tube 100-190 cm with locking screw and T-piece 550 black, showcard frame Woodline natural beech A4 resp. A3.

A4		33384-91/-1900/10
A3		33383-91/-1900/10



SHOWCARD STAND WOODLINE

Wooden stepped base Ø 160 mm, fixed aluminium tube black 320 mm with threaded bolt M10, Woodline frame natural beech A4 resp. A3 with internal thread (chalk board to be ordered separately).

A4		33384-10/320
A3		33383-10/320



ALUMINIUM TUBE

Fixed aluminium tube Ø 16 mm, length 320 mm with threaded bolt M10 to take showcard frames Woodline with internal thread.

anodized		15714-91/0320
black		15714-10/0320



WOODEN STEPPED BASE

Made of massive, natural beech wood Ø 160 mm, height 20 mm. Suits anodized or powder coated aluminium tubes Ø 16 mm.

20491-00/A



WOODLINE

TABLE STANDS

TABLE STAND "BIG CUBE"

Wooden stand quarter square made of pure oak with chalk board A5 black.
Measurements: 60 x 60 x 48 mm.

20480-00



TABLE STAND "ARCH 1/4"

Wooden stand quarter circled made of pure oak with chalkboard. Measurements small 30 x 30 x 30 mm, Measurements large 60 x 60 x 30 mm.

small (A7) | 20484-00
large (A6) | 20483-00



TABLE STAND "ARCH 1/2"

Wooden stand semi-circled made of pure oak with chalkboard A5 black.
Measurements: 120 x 60 x 30 mm.

Chalkboard to be ordered separately.

20485-00



MENUE HOLDER "RECTANGULAR"

Wooden stand rectangular made of pure oak, to hold menu cards, promotion cards, etc. Measurements: 105 x 40 x 40 mm.

Chalkboard to be ordered separately.

20482-00





CHECKOUT DIVIDER T
Made of massive wood natural beech with T-profile slot and 3 supergrips (to be inserted sideways), incl. 0,5 mm clear PVC poster protector 297 x 140 mm.

37030-00



CHECKOUT DIVIDER "WOOD"
Made of pure oak. Measurements: 300 x 30 x 30 mm. Individual logo printing available upon request.

rectangular | 37021-00
triangular | 37020-00



CASH TRAY "WOOD"
Square cash tray made of pure oak, concave quadrate shaped with stoppers for a non-slip stand. Measurements: 140 x 140 x 20 mm.

13289-00



OUTDOOR PAVEMENT SUPPORT WOODLINE
Elegant pavement support made of iron-wood with chalk boards both sides (visible size: 600 x 780 mm), black shears and hinges. Height: 103 cm, weight: approx. 6 kg.

This pavement support is **available as indoor variation**, too (available upon request).

18696-00



WOODLINE

WOODEN SHELVING

WOODEN -SHELF (MINI)

Mini wooden shelf for counters, shopping windows etc. Thanks to a modular system all wooden plug-in components can be completely disassembled. All individual parts are milled.

Total measurements (W x H x D): 139 x 360 x 96 mm.

Incl. Topper 139 x 65 mm (W x H).

Available space in the shelves: approx. 125 x 65 mm each (W x D).

All dimensions can be adjusted according to your specifications.

Customized imprint possible upon request.

Available upon request.



WOODEN SHELF

Thanks to a modular system all wooden plug-in components can be completely disassembled. The contours are milled.

Total measurements (W x H x D): 630 x 1700 x 400 mm

Incl. Topper 630 x 350 mm (W x H). Topper optionally available with insert frame for product information and advertising in A3 landscape.

Available space in the shelves:
580 x 110 x 350 mm each (W x H x D).

All dimensions can be adjusted according to your specifications.
Customized imprint possible upon request.

Available upon request.



Wooden plug-in components





ALUMINIUM DISPLAYS



ALUMINIUM DISPLAYS

LED SNAP-TYPE FRAMES



LED SNAP FRAME

Aluminium snap frame with LED lighting, profile 25 mm, to insert printed backlight foils. Supplied completely with power cable. Provided with suspension plug-ins at both frame sides for fixing either portrait or landscape. For indoor use only. Color: cold white, frame depth 19 mm.

A4 | 59100-A4/91
A3 | 59100-A3/91
A2 | 59100-A2/91
A1 | 59100-A1/91

We gladly supply you with individual printed backlight foils upon request.



CABLE SUSPENSION FOR LED SNAP FRAME

To twist into the prepared plug-ins of the frame profile, wire Ø 1,2 mm with hooks, adjustable cable with max. length 1000 mm. Set consisting of 2 pcs.

25695-00/1000





ALU SNAP-TYPE FRAMES

The classic frame – in proven OEK quality:
Carefully mounted with a grey plastic backplate and equipped with a UV-stable, non-reflective PVC protective cover, this high-end product guarantees high longevity and reliability.

- Changing the poster is possible within seconds: Open the profiles (snap) – change the poster – close the profiles (snap) – ready for use
- Profiles are made of premium, anodized aluminium
- For posters, PS-signs, chalk board etc. with a thickness of up to max. 1 mm
- Choose among 4 different profile sizes
- Corners are available in 2 different styles: mitred or with rounded chromium corners
- Equipped with a couple of extra features our "weatherproof" alu snap-type frame is also perfectly suited for outdoor use
- No chance for thieves: To protect your valuable posters from theft, we have developed a security profile allowing for the profiles to be opened only with a special security key



Remark:

Special sizes in almost all dimensions are available upon request subject to a small minimum order quantity.

Colors:

Special colors (coated) similar to RAL-colors are available upon request.

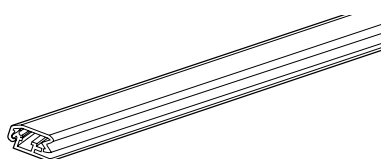

ALU SNAP-TYPE FRAME PROFILE 20 MM

Anodized aluminium profile with mitred corners, available in 4 profile sizes, grey plastic rear and non-reflective PVC cover. Other sizes are available upon request.

A5		51500-A5/91
A4		51500-A4/91
A3		51500-A3/91

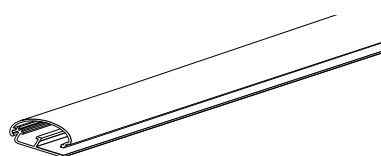

ALU SNAP-TYPE FRAME PROFILE 25 MM

Anodized aluminium profile with mitred corners, grey plastic rear and non-reflective PVC cover.

Other sizes are available upon request.

A4 (premium)		51000-A4/91
A3 (premium)		51000-A3/91
A2 (premium)		51000-A2/91
A1 (premium)		51000-A1/91
50 x 70 cm (premium)		51000-B2/91
A5 (Eco)		71-58405-00
A4 (Eco)		71-58404-00
A3 (Eco)		71-58403-00
A2 (Eco)		71-58402-00
A1 (Eco)		71-58401-00



ALUMINIUM DISPLAYS

ALU SNAP-TYPE FRAMES

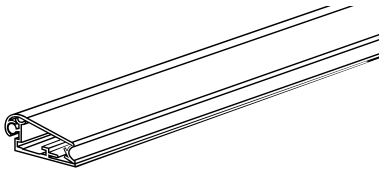

ALU SNAP-TYPE FRAME PROFILE 32 MM
Anodized aluminium snap-type frame, mitred corners or chromium corners, grey plastic rear and non-reflective PVC cover. Other sizes are available upon request.

	Premium chromium corner	Premium mitred corner
A4	51101-A4/91	51100-A4/91
A3	51101-A3/91	51100-A3/91
A2	51101-A2/91	51100-A2/91
A1	51101-A1/91	51100-A1/91
A0	51101-A0/91	51100-A0/91
70 x 100 cm	51101-B1/91	51100-B1/91

	Eco chromium corner	Eco mitred corner
A2	71-51502-00	71-51402-00
A1	71-51501-00	71-51401-00

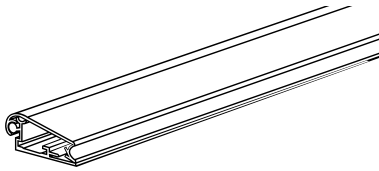

ALU SNAP-TYPE FRAME 32 MM
"WEATHER-RESISTANT" A1 PLUS
Alu snap-type frame, mitred corners, zined metallic rear plate with slightly visible rubber sealing tape (poster lays inside the tape) and non-reflective PVC cover.

51130-A1/91



ALUMINIUM DISPLAYS

ALU SNAP-TYPE FRAMES

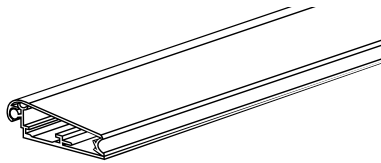

ALU SNAP-TYPE FRAME PROFILE 44 MM
Anodized aluminium snap-type frame, mitred corners or chromium corners, grey plastic rear and non-reflective PVC cover. Other sizes are available upon request.

51300-A0/91

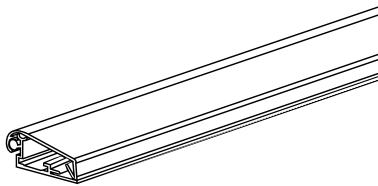

ALU SNAP-TYPE FRAME PROFILE 32 MM WITH SECURITY PROFILE
Special profile made of anodized aluminium, profile 32 with mitred corners, profile opening only possible with a special key (to be ordered separately), with grey plastic rear and non-reflective PVC cover. Other sizes are available upon request.



A1	51200-A1/91
A0	51200-A0/91

key for security profile | 57110-10



SUSPENSION RING FOR ALU SNAP-TYPE FRAME

To clamp between plastic rear plate and alu profile, variable in positioning, metal. Suitable for all profile sizes.

21365-00



PVC PROTECTIVE COVERS

Suitable for showcard frames in same size, material thickness depending on size: 0,2 mm (A5-A3) and 0,5 mm (A2 - A0 and 50 x 70 cm resp. 70 x 100 cm), non-reflective, clear.

A5	29000-A5/02
A4	29000-A4/02
A3	29000-A3/02
A2	29010-A2/05
A1	29010-A1/05
A1 plus	29010-0010/05
A0	29010-A0/05
70 x 100 cm	29010-B1/05



ALUMINIUM DISPLAYS

ALU SNAP-TYPE FRAMES



ALU SNAP-TYPE FRAME FOR WINDOWS

For special use on glass, in shopping windows etc., no rear plate at all, anodized alu profiles with mitred corners and self-adhesive tape, incl. non-reflective PVC cover, other formats upon request.

A2 (profile 32)	51166-A2/91
A1 (profile 32)	51166-A1/91
A0 (profile 44)	51366-A0/91



COUNTER FRAME

Anodized, flat aluminium profile (30 mm) to cover the double adhesive tape of the stuck window snap-type frame at the opposite.

A2	51172-A2/91
A1	51172-A1/91
A0	51372-A0/91



WINDOW SHOWCARD FRAME

For quick and professional presentation of posters in shop-windows with ambitious frame design. The plastic frame is fixed with adhesive tape on lower side and can be opened on 3 sides over magnetic tape to change posters.

For poster size A1 and A2 available – optional with passepartout for next smaller size available. Other sizes upon request. Material: PETG/PVC, size A1: 841 x 594 mm (H x W), standard color: silver + black shaded, other colors upon request.

Available upon request.



Without Passepartout



With Passepartout



INFOSTAND A4

Alu snap frame A4, adjustable aluminium tube 65 - 120 cm with black locking screw and hinge at frame's rear to adjust inclined positions, BD base Ø 255 mm, black.

(profile 25)	33324-91
(profile 32)	33334-91
with chromium corners	



TENSILE FRAME

This popular and stylish all-rounder provides you with advertising "full of tension"! Thanks to its particularly light and fine but at the same time very stable execution it can be used for almost every application. You will find the suitable suspension → **accessories** under the heading mounting accessories (suspension systems).

TENSILE FRAME

Anodized aluminium tubes Ø 9 mm, rounded plastic corners grey with integrated suspension ring, quick and easy poster change by means of clips. Special sizes are available upon request.

A4	50304-91
A3	50303-91
A2	50302-91
A1	50301-91



ALUMINIUM DISPLAYS

ALU PROFILE FRAMES



ALU PROFILE FRAMES

This system is convincing by its high quality. Designed to make your individual design ideas come true, it can withstand even demanding installation conditions. If supplied with light-weight foam panels or a similar material to ensure increased stability of the frame structure, the frames can even be used for building column panels, exhibition walls or small exhibition booths.

The alu profile frames are available in almost every size subject to a minimum order quantity of 10 pieces.

Upon request, the frames can also be supplied as mounting kit, which saves space and transport costs. The final assembly is more than easy: Just put the single profile rods together and fasten the corners using the supplied Allen key.

Remark:

You will find the suitable fixing elements for the alu profile frames under the heading → accessories (series 500).



ALU PROFILE FRAME

Stable, double-wall aluminium profile anodized, poster insert at short frame side, for posters and inserts with up to max. 4,5 mm thickness.

A4		58000-A4/91
A3		58000-A3/91
A2		58000-A2/91
A1		58000-A1/91
A0		58000-A0/91
50 x 70 cm		58000-B2/91
70 x 100 cm		58000-B1/91



ALU PROFILE U-FRAME 700 X 120 MM

For category marking onto metal shelves, for stable signs and boards with material up to 4,5 mm thickness. Set incl. 2 strong magnets Ø 50 mm, magnetic force up to 18 kgs, special sizes are available upon request.

58525-0001/91



TOPPER

Anodized alu profile frame landscape with poster insert on long side, rubber sealing for insert, base profile with double-adhesive tape. On request: PVC protective covers and PS inserts.

A4		58412-A4/91
A3		58412-A3/91



SHOWCARD STAND ALU PROFILE FRAME

BD base Ø 255 mm silver-grey, adjustable aluminium tube 65-120 cm with locking screw and T-piece 550 black, alu profile frame A3.

33393-91/-1200/33/10



LIBERTY 25 WITH ALU PROFILE FRAME A2

BD base Ø 255 mm silver-grey, fixed aluminium tube Ø 20 mm, length 160 cm, incl. fastening set with jubilee-clips and alu profile frame A2.

63112-91/1600

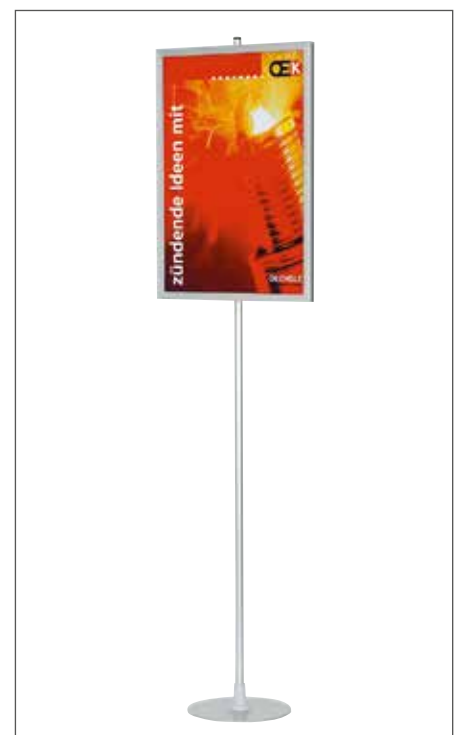

ALUMINIUM DISPLAYS

ALU PROFILE FRAMES ACCESSORIES

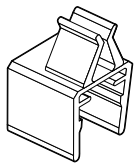

PROMOTION CARD CLIP

To attach posters or signs onto frames, in standing or hanging position, for materials with 0,3 - 2,0 mm thickness, clear.

25920-00

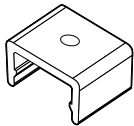

CEILING FASTENER

For a direct fixing to ceilings, whole Ø 3,5 mm, clear.

25181-00

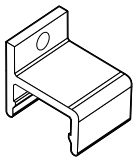

WALL FASTENER

For a direct fixing to walls, whole Ø 3,5 mm, clear.

25180-00

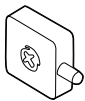

FASTENER FOR WALL

Suits only alu profile frames for an "invisible" fixing to walls, grey. For this application please order alu profile frames "with hole drilling". Depending on size we recommend to use 4 fasteners per frame.

25130-03

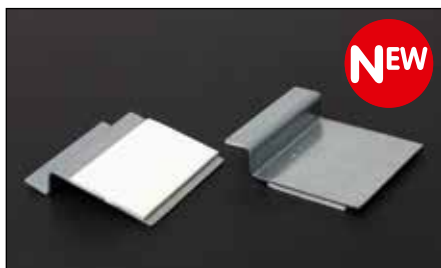
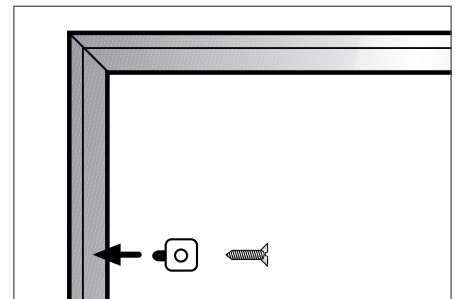

ADHESIVE HOOK

For fixation to wall of alu profile frames. Made of galvanised metal sheet. Size: 30 x 34 mm. With double-sided adhesive tape for drill free fixing, e.g. glas surfaces, mirror surfaces, etc.

25140-00



SUPPORT SERIES 500

Support made of anodized aluminium, 30 x 100 mm, assembled with series 500 adaptor for profile frames. We recommend to use these supports as pair. Other sizes are available upon request.

25840-90/0100



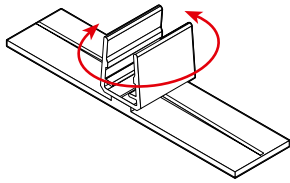

FRAME SUPPORT UPRIGHT

To support frames series 500 in an upright position, swivel-type, clear. We recommend to use these supports as pair.

25850-00

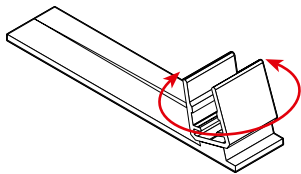

FRAME SUPPORT INCLINED

To support frames series 500 in an 15° inclined position, swivel-type, clear. We recommend to use 2 supports per frame.

25860-00

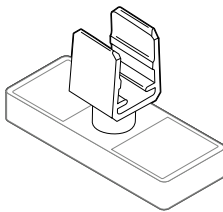

FRAME ADAPTOR

Adaptor made of clear plastics to support frames series 500 in combination with magnet bases MF suitable for taking tubes Ø 12 mm. Adaptor color: clear. Magnet bases to be ordered separately.

25200-00

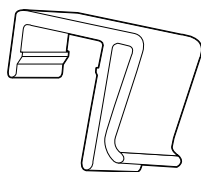

UNIVERSAL CLIP

To fix frames series 500 to shelves with front edge, metal bows, cartons or boxes, for materials with up to 4 mm thickness, clear.

25011-00

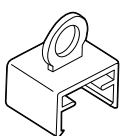

SUSPENSION RING SERIES 500

To suspend poster rails II, III and frames series 500, Ø 10 mm, clear.

25300-00



ALUMINIUM DISPLAYS

ALU PROFILE FRAMES ACCESSORIES

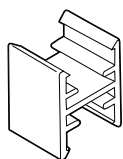

CONNECTING CLIP
To connect frames series 500, clear.

25000-00

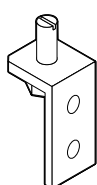

BROWSER CLIP (PAIR)
Necessary for alu profile frames if used in "Posterline" stands, clips are ready screwed to frames, aluminium.

25890-00

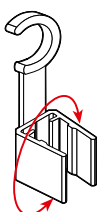

TUBE CLIP, SWIVEL TYPE (PAIR)
To suspend frames series 500 from round rails Ø 20 mm, clear.

25521-00

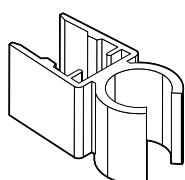

TUBE CLIPS
To fix frames series 500 to tubes. Colors: clear, grey (recommended for higher flexibility).

Ø 12 mm		25512-xx
Ø 16 mm		25516-xx
Ø 20 mm		25520-xx
Ø 28 mm		25528-xx



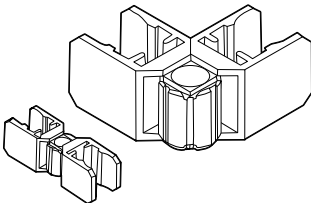

CONNECTING CLIP 2 X 90°
To connect two frames series 500 in a 90° (standard positioning) or 180° (to be indicated) angle, grey.

Available upon request.

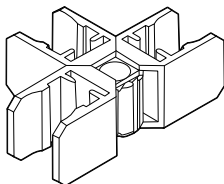

CONNECTING CLIP 3 X 90°
To connect three frames series 500 in a 90° angle each, grey.

25030-03

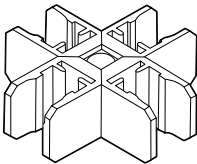

CONNECTING CLIP 4 X 90°
To connect four frames series 500 in a 90° angle each, grey.

25040-03

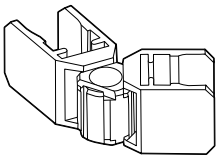

CONNECTING CLIP 2 X 105/120/135°
To connect two frames series 500 in angles of 105°, 120° or 135°, grey.

25050-03

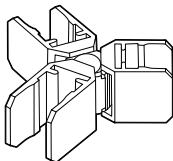

CONNECTING CLIP 3 X 105/120/135°
To connect three frames series 500 in angles of 105°, 120° or 135°, grey.

25060-03

ALUMINIUM DISPLAYS

PAVEMENT SUPPORTS

PAVEMENT SUPPORT

On the following pages you will find a selection of products which are particularly suited for outdoor use thanks to the use of special material and enhanced product features.

ALU PAVEMENT SUPPORT ECO 25

Alu pavement support, with 2 snap-type frames A1 (profile 25 mm), foldable with metal scissors, grey plastic rear, stand profile (30 x 15 mm) blank aluminium. PVC poster protector included. Total height: 100 cm.

A1 (mitred corners) | 71-52006-A1/91
A1 (chromium corners) | 71-52007-A1/91



ALU PAVEMENT STOPPER ECO 32

Alu pavement support, with 2 snap-type frames A1 (profile 32 mm), foldable with metal scissors, grey plastic rear, stand profile (30 x 15 mm) blank aluminium. PVC poster protector included. Total height: 105 cm.

A1 (mitred corners) | 71-52116-A1/91
A1 (chromium corners) | 71-52117-A1/91



ALU PAVEMENT SUPPORT PREMIUM
Aluminium tube stand in A-version foldable, with 2 alu snap-type frames (profile 32 mm), standing profile (25 x 25 mm), aluminium plate finish, grey plastic rear and non-reflective PVC cover. Total height: 120 cm.

A1 (mitred corners) | 52100-A1/91
A1 (chromium corners) | 52101-A1/91





**ALU PAVEMENT SUPPORT
"WEATHER-RESISTANT" A1 PLUS**
Aluminium tube stand in A-version foldable with 2 alu snap-type frames A1, profile 32 with mitred corners, zined metallic rear plate with slightly visible, sealing rubber tape (poster lays inside the rubber tape), with non-reflective PVC cover. Standing profile (25 x 25 mm) aluminium anodized.

52130-A1/91



CROWNER HOLDER A1
Metallic wire frame to insert promotion signs or top panels with up to max. 3 mm thickness. Suitable for alu pavement supports in A-version.

57010-00



TOP PANEL FOR A1
Promotion sign made of white polystyrene for top panel A1, visible print area approx. 63 x 22 cm.

57015-01



TOP PANEL FOR PAVEMENT SUPPORT
Roof-shaped top panel made of white, blank (non-printed) polystyrene with 3 mm thickness, to be put onto the alu pavement supports A-version. Visible print area approx. 20 cm height.

We would be glad to supply you with the ready designed and printed panel. We are looking forward to your request.

57016-01

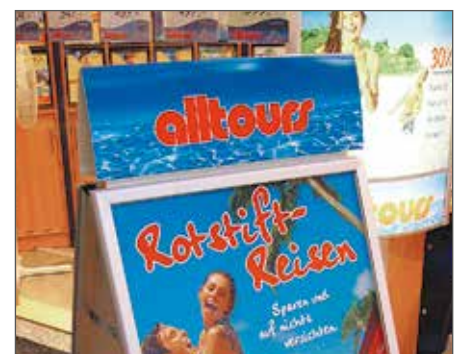

ALUMINIUM DISPLAYS

PAVEMENT SUPPORTS

LEAFLET DISPENSER

Metallic wire holder zincod to carry leaflets A4, an effective accessory suitable to fit alu-pavement supports A-version.

57090-00



CHALK BOARD HEAT RESISTANT

Chalk board made of heat resistant polycarbonate (PC). Edges: 90°, material thickness: 1,0 mm, surface: black printed, size A1.

Other sizes are available upon request.

30012-A1/10/H

POSTER-VIP ECO A1

Attractive outdoor stand with 2 alu snaptype frames A1, profile 40 mm (upper profile anodized or black) with mitred corners and plastic corner protection caps, weather resistant with sealing rubber tape, 2 rollers and fillable base (grey or black) with 30 l volume. Empty weight: 5 kgs, total height: 118 cm.

Top panel available upon request.
Retrofit of top panel possible.

anodized aluminium		54641-03/T
black		54641-10/T



POSTER-VIP "W" A1

Very stable outdoor stand with spring mechanism, with 2 alu snap-type frames A1, profile 40 mm with mitred corners and plastic corner protection caps, weather-resistant with sealing rubber tape, 2 rollers and fillable base with 42 l volume. Empty weight: 10,5 kgs, total height: 127,5 cm.

54651-00





ALU PAVEMENT STOPPER "ELEGANCE"
A1 PLUS

Elegant A-support foldable made of anodized alu profile 60 mm with mitred corners and zinc-coated metallic rear plate. Optional with magnetic tape foil to be used with posters or with black slate-coated chalk board for inscription.

with magnetic tape foil | 52818-A1/91
with chalk board foil | 52858-A1/91



PAVEMENT SUPPORT A1

Trendy pavement support made of powder coated 4-edge profile and metal rear plates. Foldable. With removable top panel made of polystyrol (branding resp. labeling custom-made possible). Magnet bags on front and backside enable a quick and uncomplicated change of posters in A1. Color: black.

Further colors and sizes are available upon request.

Available upon request.



PAVEMENT STOPPER "INDIVIDUAL"

Individually designed and produced corresponding to customer's requirements, plastic A-support (with scissors) made of PS, both-sided 4-color print. External size: 60 x 100 cm. Further product features and prices are available upon request.

This is how your individual stopper could look like. We provide design, print and the display out of one hand. Call us.



ALUMINIUM DISPLAYS

LEAFLET DISPENSER

LEAFLET DISPENSER

These "silent butlers" and helpful assistants effectively spread and market your advertisement. Don't miss to use them in your showrooms or at fairs and exhibitions.



LEAFLET DISPENSER QP

Leaflet dispenser made of aluminium system tube quickPrice, massive BD base plate 30 x 30 cm. With 3, 4, 5, or 6 inclined A4 acrylic dispensers. Arrangement in zig-zag possible.

Size (W / H / D): 30 x 30 x 140 cm

qP 3		61015-00/1400/3
qP 4		61015-00/1400/4
qP 5		61015-00/1400/5
qP 6		61015-00/1400/6



REPLACEMENT TRAY FOR LEAFLET DISPENSER QP

90-422206



LEAFLET DISPENSER PS 1

BD base Ø 255 mm black with fixed aluminium tube 800 mm, acrylic box A4, fixed with black hinge on box's rear to adjust inclined positions.





61504-10/800





OUR STRONG PARTNER

TOGETHER WE FORM AN UNBEATABLE TEAM!



- 1975  Foundation of the company – screen printery
- 1985  Further development of acrylics and plastics processing
- 2004  Successful corporate alliance with Oechsle Display Systems GmbH, Leipzig
- 2006  Move into a newly built company building



- 2013  Expansion of the production and storing areas
Extension of plastics processing
- 2015  40th anniversary
- 2016  Extension of the sample workshop for the metal area

CREATIVE PRODUCTS AND NEW DEVELOPMENTS

IN THE FIELD OF DISPLAY SOLUTIONS.

Since 1975 we develop, design, sample and produce printed goods and plastic products for sales promotion. We are an expanding medium-sized business with currently over 6.400 square meters of operating area. Our key areas are POS and displays. Our creative team offers you individual end-to-end solutions.

Werba provides a structured, modern working environment for over 80 full-time and over 130 part-time employees. We make sure to produce your product budget-conscious while always bearing in mind issues of sustainability.

Through close cooperation with our partner Oechsle Display Systems GmbH and other national and international companies we have established a well functioning business network.

This is the optimal condition to completely manufacture your product from one single source, accompanied by a competent contact person.

Our clients directly or indirectly include all major national branch businesses as well as renowned department store chains, business groups, building supplies stores, beverage producers, shop fitters and advertising agencies.

Please don't hesitate to contact us, let us give you non-binding advice and show you our possibilities. We would also be glad to visit you on site. Our team – consisting of print technologists, engineers, plastics technologists, carpenters and other specialists – gladly is at your service.

werba
display prints

werba print und display GmbH & Co. KG
Am Froschbächle 23
77815 Bühl (Baden)
Telephone: +49 (0) 72 23 / 98 64 - 0
Fax: +49 (0) 72 23 / 98 64 - 30
www.werba-print.de

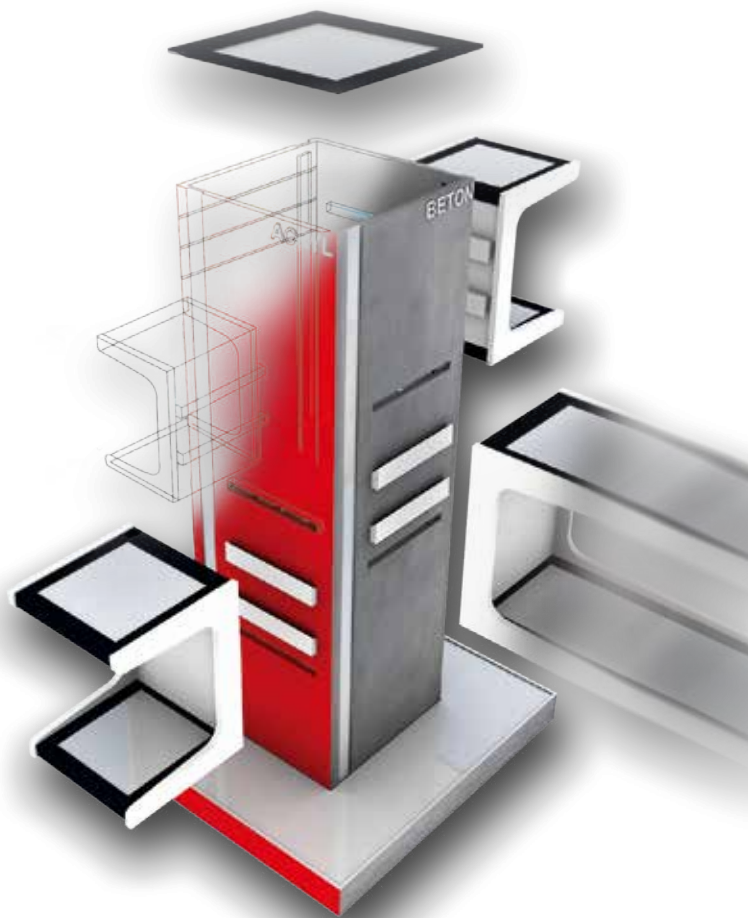

FROM ONE SOURCE

YOUR INDIVIDUALITY IS OUR SPECIALTY!

The use of different materials such as acrylics, plastics, wood, steel and aluminium offers the possibility to design customized displays according to your individual wishes. From simple bent components up to complex displays – you have the choice

and we have the solution. The products leaving our premise all differ from each other in shape, design and colour. This is quite understandable, as the customer wants to stand out from the crowd with his werba product.



1

WE
DEVELOP

2

WE
DESIGN

4

WE
PRODUCE

3

WE
SAMPLE



1

PYTHA 3D



2

PROTOTYPE
CONSTRUCTION



3

MILLING



4

BENDING



5

GLUING



6

ASSEMBLY



7

FITTING



8

DISPATCH

IDEAS AND CONCEPTS

PRECONDITIONS FOR THE SUCCESSFUL DESIGN AND DEVELOPMENT OF A PRODUCT.

1

WE
DEVELOP

It all starts with the idea or wish of our customer. Together we define the individual requirements concerning material selection, functionality and design. In joint analysis and research we determine, amongst other things, how and where the product shall be placed.

Taking these results as a basis, our team of experts – which consists of technicians, print engineers and product managers – discusses the technical possibilities for realization. The remaining essence are innovative solution proposals that take into account cost efficiency and series maturity.

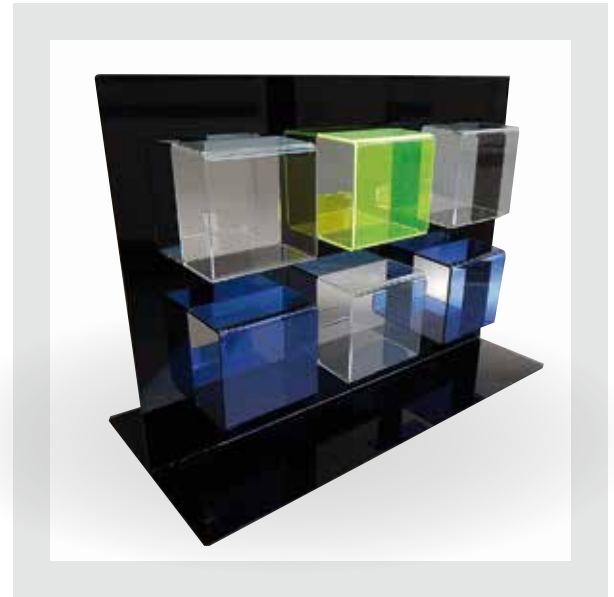

DESIGN AND CONSTRUCTION

STRONG STATEMENTS AND CONSTRUCTIVE DETAIL SOLUTIONS.

2

WE
DESIGN

BESIDES unconditional functionality and polished ergonomics your product's design plays a decisive role. Its appearance and haptics strongly influence the human decision making process. Both factors decide whether the product appeals or not.

A CLEAR distinct design makes your product stand out from the crowd. From simple technical drawings up to detailed 3D computer animations – our graphic artists and designers support the realization of your plans with their know-how and long term experience.

PROFESSIONAL visualization forms the basis for our well structured process of construction. The latest drawing programs, 3D software such as Pytha and other CAD programs directly linked to the machinery offer our process technicians the complete range of possibilities for technical implementation. Sustainability and cost-efficiency are considered in every step.

1

2

3

4



SCRIBBLE



3D VISUALIZATION

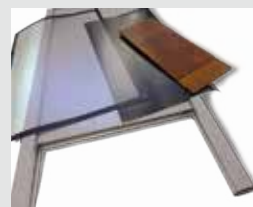

MATERIAL SELECTION



CONSTRUCTION

PROTOTYPES AND WHITE SAMPLES

THE OBJECTIVE IS TO IMPLEMENT
THE CUSTOMER'S IDEAS FAST AND SIMPLE.

3

WE
SAMPLE

PRACTICAL EXPERIENCE HAS SHOWN: The better the design and functionality of your display, the better your product sells. Our creative team supports you with word and deed on your way to perfection. If desired, we will produce prototypes and white samples for you.

Our in-house prototype workshop is fully equipped with machinery and tools. Depending on the task our technicians work with different materials such as plastics, acrylics, wood and metal. In close coordination with you our experts work out the technical details until the specimen meets your requirements. Our guiding principle is to realize our customer's ideas and wishes quickly and straightforward, in view of an ensuing cost- and quality-optimized production.



ARRAY OF SERVICES

EVERYTHING FROM ONE SOURCE

SCREEN / DIGITAL / PAD / UV-OFFSET PRINTING

According to requirement, we print in highest colour fidelity and resolution on various materials for both indoor and outdoor appliance.

MILLING / LASER TREATMENT / PUNCHING

Depending on the material, the product is specially tailored to its area of application.

BENDING / TRIMMING / GLUING:

Under the influence of temperature the product is brought in shape or joined together through crystal-clear adhesive.

WELDING

Thermoplastics from the same basis material can be welded together.

WOOD - AND METAL PROCESSING

with our design- and prototype factory we can offer many more options to finalize your product.

4

WE
PRODUCE

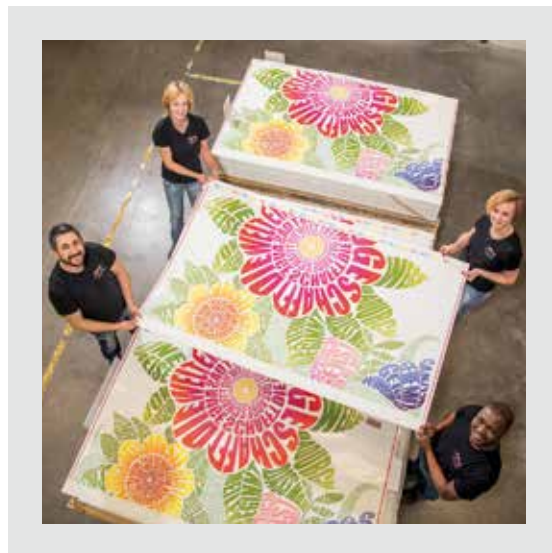

1



PAD PRINTING

2



LASER TREATMENT

3



MILLING

4



TEMPERING

5



CUTTING

6



BENDING

7



WELDING

8



PUNCHING

INDEX

A – F

A

Accessories for display hooks	85, 114, 126
Accessories for freezers	45
Accessories for refrigerated shelves	45, 46
Accessories for shopper stoppers	89
Accessories for showcard frames	31-47
Acrylic boxes	70, 169
Acrylic covers	58, 164
Acrylic displays	163 - 169
Acrylic frames	78, 164
Acrylic showcard stands	66, 67, 70, 165
Acrylic supports	122, 166 - 168
Adaptors	37, 45, 82, 86, 87, 99, 127, 189
Adhesive hook	188
Adhesive plate	86, 127
Advertising	140
Alu clamp rails	155
Alu infostands	185
Alu LEDline	9, 14, 15
Alu pavement supports	192-195
Alu profile frames	186, 187
Alu snap rails	154
Alu snap-type frames	180-184
Alu snap-type frames for windows	184
Alu tubes	54, 55
Aluminium displays	179-196
Aluminium processing	8

B

Banner hangers	92, 93
Base K	48
Bases	48-51
Basic show card frames	23
Basket display	140
Basket display for shopping trolleys	140, 141
Bicycle swivel frame	28
Book-rest	166
Bottle holder	45, 87, 161
Box for business cards	169
Browser clips	39, 138, 139, 190

C

C-hooks	157
C-rail	46
Cable suspension	144, 148, 152, 180
Caddy-clip	155
Cardboard clamp	43, 58, 76, 80, 81, 111, 127, 129, 161
Cardholder	61, 88, 95, 102, 103, 105-107, 109
Cardholder	61, 95, 102, 105-108, 167, 169, 176
Cash tray	133, 134, 177
Ceiling clamp	156
Ceiling clip	155, 156
Ceiling fastener	149, 188
Ceiling magnet	36, 156
Ceiling ring	156
Chalk board	59, 79, 103, 174, 194

Chalk board heat resistant	194
Chalk board marker	103, 174
Checkout and Sales marking	131-142
Checkout divider	132, 133, 177
Chip holder for trolleys	10
Chromium tubes	53-55
Clamp allrounder	43, 76
Clamp for oval tube	47
Clamp for rund tube	47
Clamp hook	161, 170
Clamp rail	154, 155
Clampholder	58, 75, 81, 103, 105, 106
Clampholder for signs	109
Claw fastener	84
Clip fastener for TEGO shelves	82, 83, 127
Clip fastener for ticket rail	82, 83
Clip for scanner rail	115
Clip for wire baskets	84, 88, 89
Clipboard	169
Coil-spring fastener	81, 127
Colour chart	212
Connecting clip	34, 35, 190, 191
Connector	43, 51, 60, 101, 145-147, 150, 151-153, 158, 159
Connector for poster rails	146
Contact form	211
Container	142
Corner connector	60, 146, 147, 152
Counter equipment	98-111
Counter frame	184
Customised solutions	2, 5, 120

D

DBH 39	115
DBR scanner rails	116
Dekoline showcard frames	18
Dekoline T-piece	57
Dekoline tube	54
Delicatessen & counter marking	98-112
Digits for fruits and vegetables price cassettes	110
Display clamp	44, 75
Display holder	113
Double connector	158, 159
Double holder	112
DRA scanner rail	114

E

Electronic shelf marking (ESL)	119-129
End cap	60, 132, 150, 151, 153
End piece	144, 147, 148
EXTRA with KL base	61

F

Fashion marking	47, 61
Fastener for glass boards (ESL)	125

Fastener for peg board hooks (ESL)	126
Fastener for plant container	46
Fastener for price tag pockets	171
Fastener for scanner rails	121, 123, 124
Fastener for wire shelves (ESL)	125
Fasteners	40, 42, 53, 58, 74, 80, 81, 83, 84, 85, 93, 120-126, 128, 193
Fasteners for ESL	119-129
Fastening clips for wires	33
Fixing clips	90
Fixing set	140
FK base, FK rod	101, 128
FK connector	101
FK tray clip	102
FK universal clip	102
FK-Fix base, FK-Fix rod	101, 128
Flagpole	93, 141
Flexible clip	41, 42
Floor standing stands	68-71, 175
Foil grip	144
Folded number strips	100, 111
Frame adaptor	36, 189,
Frame holder	45
Frame support	29, 40, 79, 174, 189
Frames	7, 8, 9, 15, 17-30, 40, 78, 88, 89, 138, 140, 161, 164, 165, 171, 173, 180-187, 189

G

G-clamp	41
Gallow corner connector	60
Gallow showcard stands	71, 72
Gallow T-connector	60
General Terms and Conditions	209
GLS 39 scanner rail	115
Greenline	29, 30
Grip display	141
Grip strip	146, 151
Guntia®	Special brochure

H

Hangers	146, 158, 159
Hanging hooks	32-34, 80, 149
Hanging ring	148
HE 39 scanner rail	115
Hexagonal key	51
Hinge	52, 56, 87
Hinged adaptor	86
Hinged hanger	44
Holder for acrylic cover	57
Holder for laminated signs	104

I

Ice-stick	103, 107
Illumigraph	103, 174
Individual displays	112, 159
Infoline	135-138

Infoline stands	135-138
Inlay strips	115

J

Jubilee clip	46
--------------	----

K

KE 39 scanner rail	117
Key for disassembling (ESL)	121
Keyhole fastener	42
Klick accessories (series 300)	80-87
Klick accessories for ESL	127
Klick adaptor	82, 87, 99, 127
Klick bottle holder	87, 161
Klick cardboard clamp	80, 81, 111, 127, 129
Klick connector	86
Klick grip	112
Klick label holder	79
Klick rail adaptor	82
Klick shelf barkers	78
Klick tube adaptor	86
Klick wire hooks	126
Knot chain	157

L

L-display	76
L-rail	82
L-support	104, 122, 128, 166, 167
Label holder	79
Laminate frame	19
Leaflet box	70, 168, 169
Leaflet dispenser	30, 168, 196
LED snap-type frame	180
LED-display	180
LED-rail	9, 15
LEDline	9, 14, 15
LS scanner rails	116, 117
Lying cardholder	104, 108

M

Magnetic base	38, 51, 52, 90, 92, 107, 189
Magnetic fasteners	52
Magnetic foil	171
Magnetic holder	36, 37, 84, 89-91, 93, 127
Magnetic ring	35
Menu holder base	167, 176
Metal hook	157, 170
Metal stick pin	86
Metal tube connector	150
MF-connector	51
Mini-cardholder	102

INDEX

M – V

O

Outdoor advertising _____ 19, 46, 63, 65, 76, 108, 109, 177, 182, 192-195
Oval tube clip _____ 47, 85, 127

P

Pad printing _____ 10, 205
Palett claws _____ 53
Panel hanger _____ 40
Pavement supports _____ 177, 192-195
Peg-board connector _____ 43
Pendulum clip fastener _____ 83
Pin holder _____ 85
Plant stick _____ 108
Plastic cassette for spiral bound numbers _____ 112, 159
Plastic stake _____ 108
Plastic tube _____ 54
Plastics injection moulding _____ 6, 7
Pocket swing tag _____ 114
Poster board _____ 160
Poster clamp rail _____ 148, 154, 155
Poster pocket _____ 91, 160, 170, 171
Poster protector _____ 24, 59, 140, 171
Poster rail _____ 144-146, 150, 151, 153, 154, 155
Poster rail Ambiente _____ 144
Poster rails _____ 144-146, 151, 154, 155
Poster-Snap _____ 154
Poster-VIP _____ 194
Posterline _____ 139
Posterman _____ 175
Price cassette for beverages _____ 158
Price cassettes _____ 98-100, 110, 111, 158, 159
Price cassettes for fruits and vegetables _____ 98, 110, 111
Price display _____ 7, 100, 111, 112, 158-160
Price displays for beverages _____ 160
Price tag pocket _____ 170, 171
Priceboard _____ 153
PRIMA shelf management systems _____ 12, 13, Special brochure
Product development _____ 5
Promotion card clip _____ 35, 150, 188
PVC counter support _____ 104
PVC covers _____ 91, 160, 170
PVC foils _____ 59, 79, 140, 171, 183
PVC parts _____ 170, 171
PVC poster protectors _____ 24, 59, 140, 171
PVC support _____ 104
Pyramid base _____ 49

R

Rail ring _____ 148, 153
Replacement tray for leaflet dispenser _____ 196
Retaining clip _____ 38

S

S-hook _____ 157
Scanner rails _____ 115-117
Security profile _____ 181, 183
Shelf divider and pusher system _____ 12, 13, Special brochure
Shelf equipment _____ 77-117
Shelf holder _____ 41
Shelf management systems _____ 12, 13, Special brochure
Shopper stoppers _____ 88-91, 94-97, 115
Shopper stoppers for scanner rails _____ 94-97
Shopping baskets _____ 141
Showcard frames _____ 7, 17-30, 57, 59, 78, 79, 88, 98, 138, 140, 161, 171, 174, 180-186
Showcard frames - special sizes _____ 25-28
Showcard holder DK _____ 53
Showcard holders _____ 47, 53, 73, 74-76
Showcard holders for wire baskets _____ 53, 74
Showcard stand FL _____ 58
Showcard stand for Euro paletts _____ 76
Showcard stand K _____ 122
Showcard stand KL _____ 61, 122
Showcard stands _____ 7, 18, 19, 21, 30, 61-72, 165, 176, 185, 187
Signholder _____ 91, 112, 113
Slatwall-clip _____ 85, 127
Sloping fastener _____ 84
Snap-type frames _____ 180-184
Snap-type frames for windows _____ 184
Special sizes - showcard frames _____ 25-28
Spring clip _____ 94
Square hanger _____ 44
Stepped base _____ 49, 68, 175
Stick _____ 85, 86, 103, 107, 108, 109, 127
Stock inventory clip _____ 114
Storage container _____ 142
Suction pad _____ 39, 85
Supergrip _____ 91, 95, 113
Suspension _____ 159
Suspension cover _____ 160, 170
Suspension hook _____ 32, 80, 93, 149, 152, 157, 158
Suspension ring _____ 31, 148, 150, 152, 153, 183, 189
Swing fastener _____ 84, 127
Swivel frames _____ 88, 89
Swivel hinge _____ 87
Swivel-cardholder _____ 88, 95
System tube _____ 151, 196

T

T-connector _____ 60, 147
T-piece _____ 29, 56, 57
TE scanner rails _____ 117
Tensile frame _____ 85
Top panel, Top panel holder _____ 193, 195
Topper _____ 186
Tray clip _____ 102

V – Z

Triangular hanger _____	44
Tube adaptor _____	86
Tube clips _____	34, 40, 41, 84, 127, 150, 190
Tube connector _____	150-152
Tube hooks _____	93, 157
Tubes _____	53-55
Twin-set frames _____	20, 67
Twin-set tube _____	55

U

U-frame _____	28, 57, 66, 165, 186
Universal clamp _____	44, 75, 109, 111, 128
Universal fasteners (ESL) _____	120, 121, 123, 124
Universal hooks _____	156
Universal sign holders _____	93

V

Visionline _____	75, 87, 105-107, 127
------------------	----------------------

W

Wall fastener _____	42, 85, 86, 127, 188
Weather resistant alu snap-type frames _____	182
Werba print and display _____	198 - 205
Window showcard frame _____	171, 184
Wire hooks _____	33
Wobbler _____	96, 97
Wooden base _____	174, 175
Wooden pavement support _____	177
Wooden shelves _____	178
Wooden showcard frames _____	173
Wooden showcard stands _____	175
Wooden table stands _____	176
Woodline frames _____	173
Woodline showcard stands _____	175
Woodline table stands _____	176

GENERAL TERMS AND CONDITIONS

The following terms and conditions apply to all contracts concluded by us, provided that our contractor is an entrepreneur. Arrangements derogating from these Terms and Conditions, in particular regulations to the contrary in other Terms and Conditions shall not become part of the contract. These Terms and Conditions also apply to all further transactions with the contractor.

1. QUOTATION AND CONTRACT CONCLUSION

Our quotations are non-binding. The contract does not come into effect until the order is delivered or confirmed in writing through us. The conclusion of the contract shall be subject to the reservation of complete and correct self-supply, insofar as sufficient hedging transactions have been settled and are necessary for contract conclusion. Price lists, catalogue and brochure images as well as technical drawings and indications concerning price, measurement and weight included therein are non-binding. We reserve the right to make changes in the technical realization of our products, if this does not considerably affect usage and appearance of the product. Color samples and specifications do in any case represent approximate values only. Also for partial deliveries we explicitly reserve the right of marginal color deviations.

2. PRICES

Unless anything else has been agreed on in writing, all prices are quoted ex works excluding packaging and VAT. A minimum order surcharge of 5,- Euro is invoiced for order values that amount to less than 50,- Euro.

3. DELIVERY

We are entitled to execute deliveries by instalments according to the production progress as far as this is reasonable for the customer. The customer is entitled to withdraw from the contract on account of a delay in delivery only after he has threatened to do so granting us adequate additional time. A delay of delivery on our part is not given if the customer is in arrears with a payment towards us which arises out of the same or another contract. For special models we are entitled to carry out deliveries that deviate in quantity up to $\pm 10\%$ of the quantity ordered, these deviations are due to production.

4. DISPATCH

Dispatch shall always be at the risk of the customer, even if postage paid delivery is agreed upon. Packing will be charged at cost price and will not be taken back.

5. TERMS OF PAYMENT

All accounts shall be paid within 30 days after the invoice date. The goods may be dispatched - at our option - cash on delivery or cash before delivery. A customer is entitled to offset against our claims only if the counterclaim is undisputed or a legally enforceable title is existent. The customer can only claim a right of retention provided that his claims arise from the same contractual relationship.

6. RESERVATION OF TITLE

Goods delivered shall remain our property until all claims arising from the business relationship with the customer are paid in full. In the case of a current account, the property subject to reservation of title shall serve as security for our every payment balance claim.

The purchaser is only entitled to sell the products subject to reservation of title as part of proper business activities and as long as he is not in default of payment. Other actions which endanger our property are excluded. The customer assigns any receivables arising from the resale of the goods to us with immediate effect.

The customer is granted the authorization to collect the claims ceded to us; we are entitled to withdraw this authorization as well as the authorization to resell the goods subject to reservation of title if the customer does not fulfil his obligations towards us.

The customer will at any time provide us with all requested information regarding the goods subject to reservation of title or regarding the claims that hereafter have been ceded to us.

The customer shall immediately notify us of any access or claims by third parties regarding the goods subject to reservation of title and provide us with the necessary documents. The customer will also immediately notify the third party of our reservation of title. The customer shall bear the costs of a defence against such accesses and claims.

7. NOTIFICATION OF DEFECTS, WARRANTY, LIABILITY

The customer shall examine the goods for damages or material defects immediately after receiving, latest within one week after delivery. Notification of defects must be made immediately, latest within one week after discovery. If the goods are deficient or lack warranted qualities our warranty is restricted to repair or replacement at our option for the time being. Hereto the customer must grant us a reasonable period of time and opportunity. We bear the expenses necessary for the purpose of repair, provided that these are not disproportionate. Expenses that exceed the sales price are to be regarded disproportionate.

If repair or replacement is not reasonable for the customer or if the repair fails at least twice, the customer is entitled to lower the purchase price or withdraw from the contract.

Compensation claims obtain only according to the following regulations:

We do only bear liability in the case of intent or gross negligence of the company or our assistants and vicarious agents. This does not apply for the breach of fundamental contractual obligations, in particular compensation claims due to non-performance, on account of delay or in case the contract cannot be fulfilled on our part, for claims resulting from injury to life, body or health and in the case of a liability under the product liability legislation. In the event of a breach of essential contractual duties which is based on other circumstances than intent or gross negligence, liability is limited to foreseeable and typical damage.

Claims arising from material defects lapse one year after delivery of the goods.

8. DRAFTS AND SAMPLES

Our drafts and samples of all kind may neither be imitated or copied, nor made available to third parties without our prior permission in writing. In each case of culpable violation the customer is obliged to pay us a contractual penalty of 5.000 Euro which is taken into account to further compensation claims.

9. PLACE OF JURISDICTION AND PERFORMANCE

Place of performance for the consignment or service to be provided by us is Leipzig/Donau.

Place of jurisdiction is 89312 Günzburg. German law shall apply exclusively.

As of 02/2011







DISPLAY COLLECTION

COLOR CHART



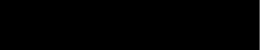

In our extensive OEK color range you will certainly find the "right match". Select your desired color and replace the suffix "xx" of the article number by the corresponding color code ().

The following shown colors can only reflect approximately the actual color shade of the final product due to printing techniques.

STANDARD Colors

	White (01) similar to RAL 9010, pure white
	Grey (03) similar to RAL 7035, light grey
	Yellow (04) similar to RAL 1018, zinc yellow
	Red (06) similar to RAL 3000, flame red
	Green (07) similar to RAL 6032, signal green
	Blue (08) similar to RAL 5015, sky blue
	Black (10) similar to RAL 9005, jet black

ADDITIONAL COLORS

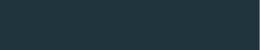
	Orange (05) similar to RAL 2008, bright red orange
	Traffic red (3020) similar to RAL 3020, traffic red
	Ultramarine blue (28) similar to RAL 5002, ultramarine blue
	Emerald green (6001) similar to RAL 6001, emerald green
	Traffic green (6024) similar to RAL 6024, traffic green
	Anthracite gray (7016) similar to RAL 7016, anthracite gray

SPECIAL COLORS

	Transparent (55)
	Silver (30) matt
	Metallic silver (34) similar to RAL 9006, white aluminium
	Polished chromium (35)



YOUR COMPETENT DUO
FOR CREATIVE SOLUTIONS

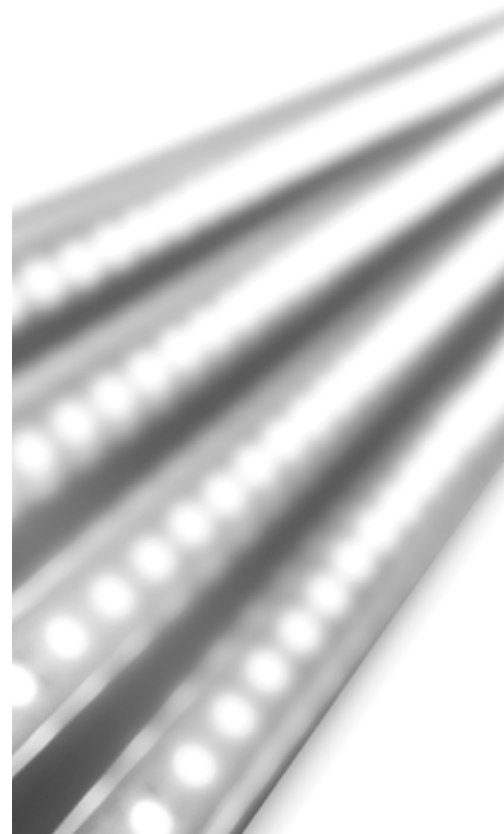

werba print und display gmbh & co.kg

Am Froschbächle 23
D-77815 Bühl (Baden)
Phone +49 (0) 72 23 / 98 64-0
Fax +49 (0) 72 23 / 98 64-30
www.werba-print.de

Oechsle Display Systeme GmbH

Rudolf-Wanzl-Straße 13-15
D-89340 Leipheim
Phone +49 (0) 82 21 / 27 98-0
Fax +49 (0) 82 21 / 27 98-27
www.oechsle.de